



*USE PACKARD SERVICE*

PACKARD MOTOR CAR COMPANY  
Detroit 32, Michigan



OPERATION  
AND CARE  
OF YOUR

PACKARD

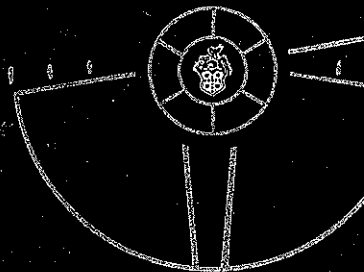

# Congratulations

You are now a member of the Packard family . . . a new and different feeling of personal pride has taken possession of you. If you will but peruse these few pages you will learn *how* to get the *very most* from your value-wise investment.

We welcome you to a family that has been traditionally growing throughout the world ever since 1899. During all those years, so it has always seemed, one of man's great ambitions has been to *own a Packard . . . your ambition is now fulfilled.*

When others may choose to "Ask the Man Who Owns One", that "*man*" can now most surely be *you*.

Your new Packard is precision-built—like a fine timepiece. We know that you will take pleasurable pride in giving your new Packard the kind of care it so justly deserves. And, by so doing, you will invariably receive countless miles of trouble-free motoring enjoyment for yourself and your family.

Yes, take a brief tour through these easy-to-understand pages and thousands of more miles in this new Packard are yours for the asking.

CONGRATULATIONS on your wise selection of one of your major investments for the years to come.

PACKARD MOTOR CAR COMPANY  
DETROIT 32, MICHIGAN

# Contents

	Page
<b>MANUFACTURER'S WARRANTY</b> .....	4
<b>TIRE WARRANTY</b> .....	4
<b>PACKARD OWNER'S SERVICE POLICY</b> .....	5
<b>INSTRUMENT CLUSTER</b> .....	6
Temperature Gauge.....	6
Fuel Gauge.....	7
Battery Charge Indicator.....	7
Oil Pressure Indicator.....	7
Speedometer.....	9
Clock.....	9
<b>SMART—FUNCTIONAL CONTROLS</b> .....	9
Ignition Switch.....	10
Light Switch.....	10
Headlight Beam Selector.....	11
Directional Signal.....	12
Cigar Lighter.....	12
Ash Receivers.....	13
Glove Drawer.....	13
Front Seat Adjustment.....	13
Windshield Wipers.....	14
Parking Brake.....	14
Power Brake.....	15
Door Handles and Locks.....	16
Trunk Lock.....	17
Bonnet Lock.....	17
Power Steering.....	18
Heating and Ventilation System.....	19
Ultramatic Drive.....	21
Starting the Engine (With Ultramatic Drive).....	22
Overdrive.....	23
<b>LUBRICATION</b> .....	24
Types of Engine Oil.....	24
Selecting Engine Oil.....	25
Oil Grade and Temperature Chart.....	25
Lubrication Chart.....	26-27
Engine Oil Level.....	28
Engine Oil Additives.....	28
Changing Engine Oil.....	28
Air Cleaners.....	28
Power Steering Oil.....	29
Transmission Oil.....	29
Ultramatic Drive Fluid.....	30
Rear Axle Lubricant.....	30

# Contents

	Page
Universal Joints.....	30
Rear Springs.....	30
Chassis.....	31
Seasonal and Periodic Operations.....	31
<b>COOLING SYSTEM</b> .....	31
Coolant Level.....	32
Draining the System.....	33
Rust Preventive.....	33
Anti-Freeze.....	33
Anti-Freeze Chart.....	33
<b>ELECTRICAL SYSTEM</b> .....	34
Battery Care.....	34
Light Bulb Chart.....	35
Fuse Chart.....	35
Headlights.....	36
<b>WHEELS AND TIRES</b> .....	36
Tire Pressure.....	36
Safety Rim Wheels.....	36
Cross Switching Tires.....	37
Changing Wheels.....	38
<b>DRIVING YOUR NEW CAR</b> .....	39
Starting the Engine.....	39
The Right Gasoline.....	39
Pushing or Towing (With Ultramatic Drive).....	39
Pushing or Towing (With Overdrive).....	40
Break-In Period.....	40
Starting After a Stop.....	41
Driving on the Highway.....	41
Warm-Up in Cold Weather.....	41
A Tip on Safe Driving.....	41
Mountain Driving.....	42
Gasoline Mileage Depends on the Driver.....	42
<b>CLEANING THE CAR</b> .....	43
Painted Surfaces.....	43
Glass.....	44
Chromium Plating.....	44
Upholstery.....	44
Convertible Top and Rear Window.....	45
<b>SPECIFICATIONS</b> .....	46-49
<b>SERVICE AND PARTS</b> .....	50-51
<b>MANUALS AND PUBLICATIONS</b> .....	52-53
<b>MODERN TOOLS AND EQUIPMENT USED</b> .....	54
<b>ACCESSORIES</b> .....	55-77

**Manufacturer's  
Warranty**

Packard Motor Car Company makes this warranty to you, as the original retail purchaser of a new Packard car. The warranty will be effective for a period of ninety (90) days from the purchase date or 4,000 miles of operation, whichever event shall occur first.

Should your new Packard car, during such period, require replacement of any original part (except tires) adjudged by the selling Packard Dealer and acknowledged by us to be defective in material or workmanship, we will pay such Dealer for your account, for the Packard part used and for the labor of replacing the part. Arrangements for the necessary work will be made by you with such Dealer, to whom you will look in respect to the quality of the work performed.

If your car or any functional part thereof becomes inoperative, the provisions of the preceding paragraphs will apply to the arrangements you make with any Packard Dealer for the replacement of the functional part.

This warranty shall not apply if your new Packard car shall have been repaired or altered in any way so as in our judgment to affect its stability or reliability, or has been subjected to misuse, neglect or accident.

Other than the foregoing, no warranty, express or implied, is made by, nor shall any obligation or liability accrue against, Packard Motor Car Company.

The Manufacturer reserves the right to change the design or specifications of any Packard product or part thereof. If Manufacturer shall make such changes of design or specification there will be no obligation to make such changes upon any Packard product or parts previously shipped, or to install or furnish any other or different parts than were thereon when shipment was made

**Tire  
Warranty**

All tires supplied as original equipment carry the following tire manufacturer's warranty:

"Every tire of our manufacture, bearing our name and serial number, is guaranteed by us to be free from defects in workmanship and material, without limit as to time or mileage, and to give satisfactory service under normal operating conditions."

"If our examination shows that any tire has failed under the terms of this guarantee, we will either repair the tire or make an allowance on the purchase of a new tire."

**Packard Owner's Service Policy  
As Supplied By Your Dealer**

We issue this "Packard Owner's Service Policy" to furnish you with credentials needed to obtain the benefits of the "Manufacturer's Warranty" and to describe the additional services provided by us as an independent business organization.

We have given your new Packard car careful inspection and adjustment before delivery in accordance with Packard Motor Car Company's recommendations.

We have also issued to you an "Owner's Identification Card," which is supplemental to the Owner's Service Policy, and provides convenient evidence of the date of original purchase, the vehicle identification, and our name as the selling Packard dealer. It is primarily intended for your use when touring.

If your new Packard car does not function to your entire satisfaction during the first 90 days or 4,000 miles of operation, whichever occurs first, and the difficulty can be remedied by adjustment, we will, during such period, furnish this service to you without charge, provided the difficulty is not due to misuse, neglect, or damage due to accident or otherwise.

If in our judgment the replacement of an original part (except tires) is required because of a defect in material or workmanship, we will, during such period, make the replacement, and present your account for this service to the Manufacturer for payment under the terms of the "Manufacturer's Warranty," printed in "Operation and Care of Your Packard," provided your new Packard car has not been repaired or altered in any way so as in our judgment to affect its stability or reliability, and has not been subjected to misuse, neglect or accident.

Due to present or prospective material shortages caused by the national emergency, or for other valid reasons, we reserve the right hereunder, in making replacements, to use parts, accessories, or equipment made of such materials and of such specifications as in our or the Manufacturer's absolute discretion shall appear proper, without regard to the composition or specifications of the items replaced, or to refrain from making any such replacement should such course appear advisable to us or to the Manufacturer.

We will perform the services as listed on the attached coupons without charge. In the event you are 50 miles or more away from our Service Department when these services become due, and if this Service Policy is validated in the manner as indicated on the face thereof, you may obtain the services without charge from any Packard Dealer, who will be reimbursed by us.

*Deliver  
Preparation*

*Owner's  
Identification  
Card*

*Service  
the  
Warranty*

*1000  
3000-  
Inspection  
Adjustment*

## Instrument Cluster

The instruments are located in a raised cluster on the instrument panel directly in front of the driver. They are recessed in the cluster panel for the purpose of eliminating sun glare and reflections. Their location and size have been calculated to provide the maximum in convenience and readability.

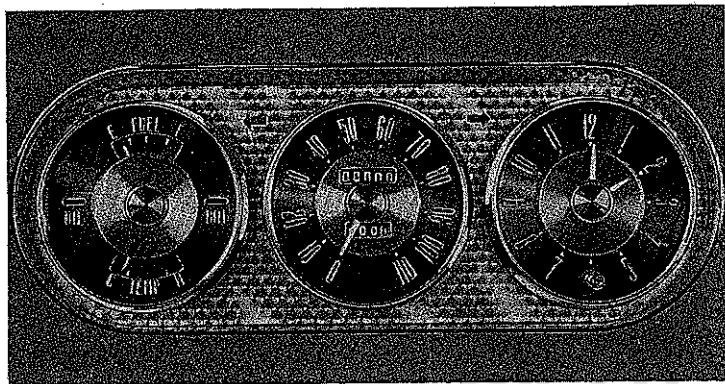

## Temperature Gauge

The temperature gauge, marked "TEMP" registers the temperature of the water or anti-freeze in the cooling system. The gauge registers only when the ignition key is turned either to the left or right. When the engine is running at a normal temperature the pointer should center approximately between the "C" (cold) and "H" (hot) position. The pointer may register toward the "H" position during long continuous driving in hot weather, or when in slow moving traffic. This condition is not alarming, as the pressure controlled overflow will normally prevent fluid losses at temperatures up to about 233° F. If the pointer moves over to or passes the "H" mark, under reasonably normal driving conditions, have your cooling system checked immediately by your Packard dealer.

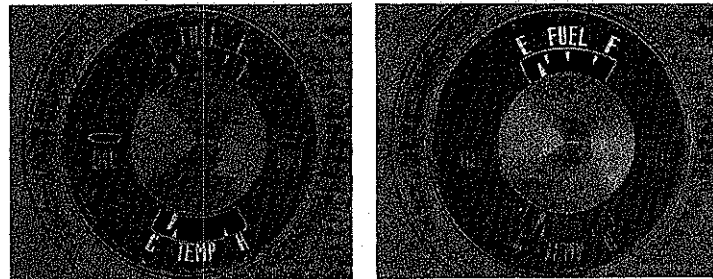

The fuel gauge indicates the quantity of gasoline in the tank and this gauge also operates when the ignition key is turned from its off position without the engine running.

The battery charge indicator marked "BAT", is a signal light which determines for you whether the battery is being charged or discharged.

This indicator will light up when the ignition key is turned to the "on" position. When the engine is running at idle or slow speed, the light will remain on due to more electrical energy being consumed than is being delivered to the battery; therefore, the battery is discharging. Headlights, radio, and heater will affect the rate of battery discharge. With these in operation, and while driving at slow speeds with reduced generator output, this will cause the signal light to indicate a discharged condition. However, under normal driving conditions, the light will remain out indicating that the proper amount of electrical energy is being delivered to the battery to take care of the electrical load.

The oil pressure indicator, marked "OIL," also is a signal light and it will light when the ignition key is turned from its off position and before the engine is started. This indicator sometimes will light up or

## Fuel Gauge

## Battery Charge Indicator

## Oil Pressure Indicator

will flicker when the engine is idling even though the idle oil pressure is adequate; however, the light should go out when the engine is speeded up. If the signal light remains illuminated after the engine speed is increased, the engine should be shut off and the cause of the trouble determined.

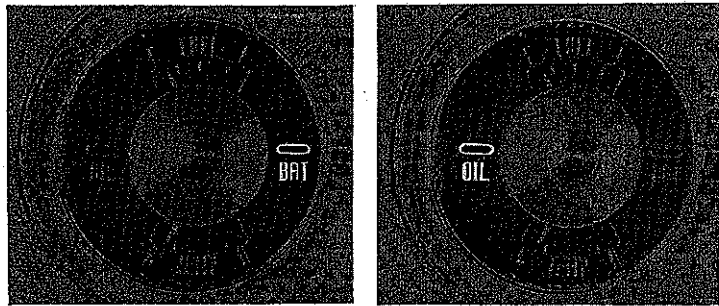

#### NOTE

The three instruments you have just read about, the "TEMP" gauge and the "BAT" and "OIL" indicators, will tell you when something is not working right and it is advisable to visit an Authorized Packard Service Station if:

- (a) the "TEMP" gauge pointer should go over to "H" and stay there.
- (b) the "BAT" indicator should stay lighted all the time you're driving.
- (c) the "OIL" indicator should stay lighted when the engine is speeded up above idle speed.
- (d) the "BAT" and "OIL" indicators do not light at anytime which may be caused by a burned-out bulb.

The speedometer, in addition to registering car speed, also indicates total mileage driven. On those models which includes a trip mileage indicator on the speedometer, figures may be set at zero by pushing upward on the re-set knob (located under the instrument panel and to the left of the speedometer) and then held there and turned to the right.

The clock is electrically operated and may be set by pulling out the re-set knob and turning it either to the right or to the left. Should it lose or gain time, turn the notched sleeve behind the re-set knob either to the left or to the right as required, or note the amount of loss or gain per day and have it adjusted the next time you visit your Packard Dealer.

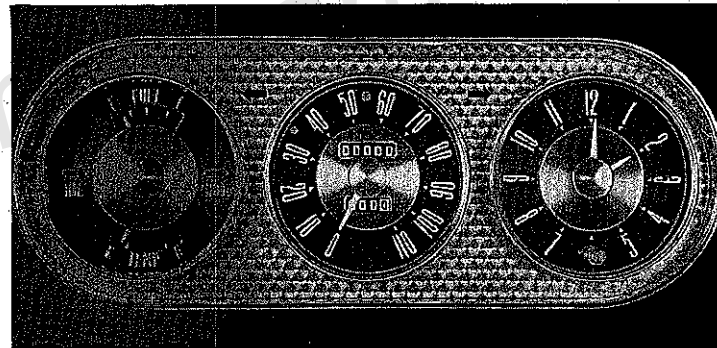

The controls of your new Packard have been designed for the utmost convenience of operation. They were handsomely styled to blend with the car's design and they create a smart ensemble that enhances its beauty.

*Speedometer*

*Clock*

**Smart  
Functional  
Controls**

ASK THE  
MAN WHO  
OWNS ONE

The ignition key is your symbol of the right to safe comfortable driving. Besides operating the ignition switch, this key will lock or unlock the doors. A separate key (octagonal handle) will operate the luggage compartment and glove drawer locks. Safeguard the treasured possession, that is your new Packard, by *always* removing the keys when leaving it unattended.

### Switch

The ignition switch has three positions. When the key is in the center position or, in other words, straight up and down in the lock, the switch is "off". When the key is turned to the left, the engine cannot be started but electrically operated accessories can be used and the instruments can be checked. The engine can be started only when the key is turned to the right.

For convenience, the switch keyhole is lighted when the light switch knob is pulled out to the first or parking light position.

### Switch

The light switch is a combination switch which controls the lighting of the parking lights, headlights, instrument cluster lights, and map lights.

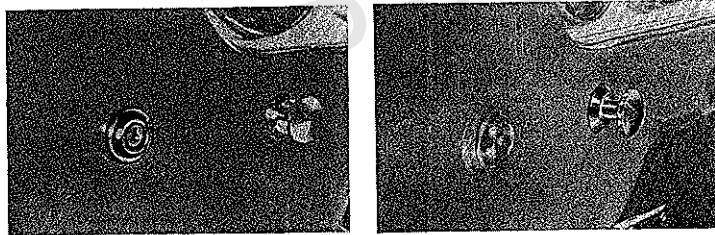

The PARKING LIGHTS are turned "on" by pulling the switch knob out to the first notch.

The HEADLIGHTS will light by pulling the knob out all the way.

The INSTRUMENT CLUSTER LIGHTS and the MAP LIGHTS are controlled by turning the light switch knob. When the knob is turned all the way to the left, the instrument lights and the map lights will be out.

The MAP LIGHTS are installed for your convenience. They will light when the knob is turned to the right far enough to reach a "notch" in the switch and they can be turned on without pulling the knob out to light the parking lights or the headlights.

When the knob is turned past the first "notch" with the parking lights or headlights on, the map lights will go out and the instruments will be brightly lighted as the second "notch" is reached. When the knob is turned farther to the right the instrument lights will gradually become dimmer as the knob is turned. The instruments will be very dimly lighted when the knob is turned all the way to the right.

The headlight beam selector "dimmer" switch, operated by a button with the left foot, controls the beam thrown by the headlights which have a high beam for country driving and a low beam for city or traffic driving and for meeting oncoming cars.

When the lights are on the high beam, a red light will light up between the figures "50" and "60" in the speedometer dial.

The high beam enables you to see far ahead at night but, to a driver coming in the opposite direction, its glare is dangerous. Good drivers are always courteous. If you are driving with the high beam switched on and a car approaches from the opposite direction, step on the selector button and thereby switch to the low beam until the car has passed and then again step on the button to switch back to the high beam. This will pay off in safety both for yourself and for others.

### Headlight Beam Selector



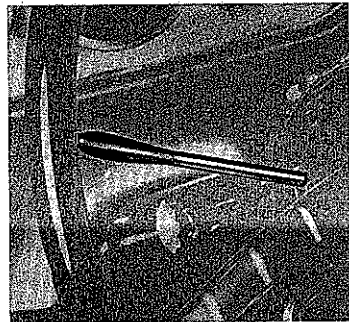
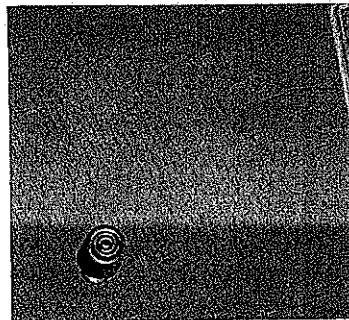

*ctional  
Signal*

The directional signal indicates the direction in which you intend to turn. It does this by causing the affected front directional signal filament in the parking light and in the tail light to flash on and off.

To signal a turn, move the lever in the direction in which you are going to turn the steering wheel to make the turn. In other words, move the lever upward to signal a right turn and downward to signal a left turn. It is not necessary to hold the lever in either position since it will remain in position until the turn is completed, when the switch will automatically trip off.

While the directional signal is in operation a green arrow indicator light in the instrument cluster face plate will flash on and off on either the right or left side of the speedometer, indicating the direction of turn that is intended by the driver.

*Lighter*

The cigar lighter is operated by pushing inward on the lighter knob. The lighter will return to its normal position when it is hot enough to light your cigar or cigarette. Rear compartment lighters work in the same manner.

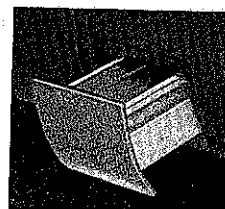
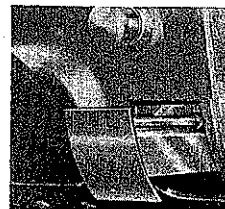

*Ash R*

Both front and rear ash receivers are placed for maximum convenience to driver and passengers. They blend with the interior beauty of the car and are readily removable for easy cleaning.

*Glove*

Packard's spill-proof glove drawer provides spacious storage for maps and other items. It is opened by means of a finger grip at the bottom of the drawer and may be locked with the octagonal handled (cornered) key which also operates the trunk lock.

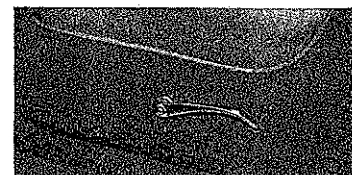
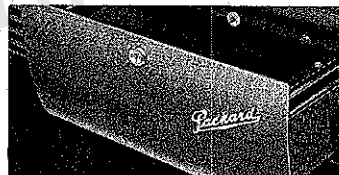

*Front  
Adjus*

A front seat adjustment makes it possible for you to locate the seat in the most comfortable position—forward and up for drivers of short stature, or backward and down for taller drivers. Adjustment is made by raising the handle and sliding the seat backward or forward to the desired position. It will lock in place when the handle is released. Enjoy all the comfort that is built into your Packard seat by occasionally changing its position during long drives.

ASK THE  
MAN WHO  
OWNS ONE



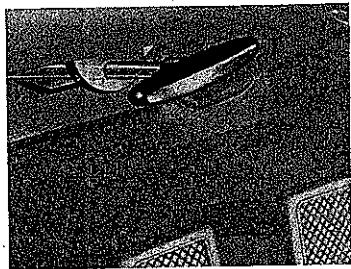
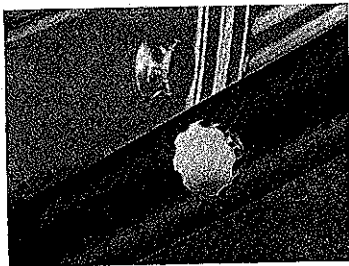

### Windshield Wipers

The windshield wipers can be started by turning the control knob (located on the left side of the steering column) toward you or, in other words, toward the rear of the car. The speed of the wiper blades also can be regulated by turning the knob in this direction.

A windshield washer is available as an accessory to assure clear vision which is vital for relaxed, safe driving. The washer supplies two jets of water that spray on the windshield so that a few strokes of the wipers provide a thorough cleaning when the windshield becomes spotted with road splash, traffic film, etc.

To operate the washer, first turn the wiper control knob toward the front of the car and hold it in this position for a few seconds to start the water spray and then turn the knob toward the rear of the car to start the wipers.

### Brake

Packard's "Safti-set" parking brake, or hand brake, is applied merely by pulling straight back on the handle located to the left of the steering column. There are no intermediate positions for the parking brake handle—the brake is either all the way "on" or all the way "off." This eliminates the possibility of driving with "half-on" brakes. Release the brakes by turning the handle to the left, allowing it to return to release position.

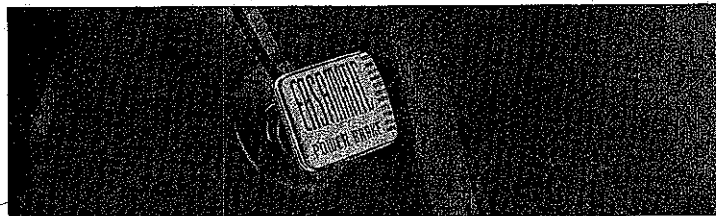

### Power

All 26th Series Packard Patrician 400's are equipped with the Easamatic Power Brake as special equipment. It is also available as optional special equipment on the "Clipper," "Clipper Deluxe" and "300" models.

Packard cars when equipped with Easamatic Power Brakes provide an outstanding safety feature by having positive brake action available for the driver the instant the brake foot pedal is depressed.

The Easamatic unit is a combined vacuum and hydraulic unit for power braking, utilizing engine intake manifold vacuum and atmospheric pressure for its operation. It is a self-contained unit having no external rods or levers exposed to dirt and moisture.

Packard Easamatic Power Brakes have a triple safety factor for providing brake action at all times—vacuum from the engine manifold, an emergency vacuum reserve tank that provides vacuum should the engine stall, and conventional brake pedal action.

The foot brake pedal used with the Easamatic brake unit is conveniently located by being suspended from a bracket attached to the dash panel. This location permits quicker brake action by the driver, as the brake pedal is three inches nearer to the floor in the released position than a car equipped with conventional brakes. This reduced pedal travel brings the height of the pedal down to the approximate height of the accelerator pedal, permitting the driver to shift his toe from one pedal to the other without lifting his heel from the floor.



Lighter pedal pressures are required to apply the brakes.

It should be remembered that only gentle pressure of the toe is required to obtain brake action, and care should be exercised when applying the brakes to avoid stopping the car too abruptly.

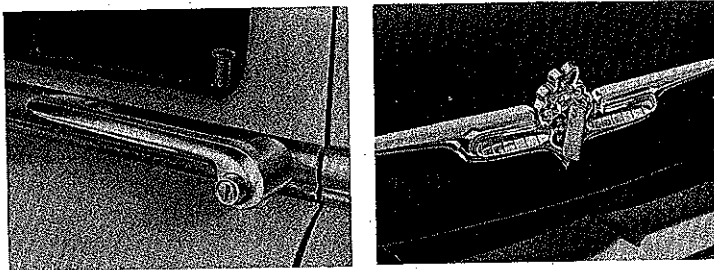

### *Door Handles Locks*

The outside door handles are of the newest snag-proof design. To open a door, simply grasp the handle, push inward on the button, and pull outward on the handle.

A door check is incorporated in each door to prevent it from closing of its own weight after being fully opened.

All doors may be locked from the inside by pushing downward on the locking knobs or buttons located on the window finish moulding. A front door locked from the inside can be opened just by turning the inside door handle. On rear doors, the lock button first must be raised.

Either of the front doors may be locked from the outside with the ignition key. The front doors cannot be locked accidentally. If an inside lock button is placed in the locked position while the door is open, it will snap to its unlocked position when the door is closed.

Rear doors may be locked from the outside by pushing down the lock button and then closing the door. The lock button first must be raised before the door can be opened.

The luggage compartment is unlocked simply by turning the octagonal handled (cornered) key to the right at which time the lid will automatically raise a short distance. An ornamental lifting handle is provided to fully raise the lid and counter-balance springs will hold it open. The lid will be locked automatically when it is pushed to the closed position.

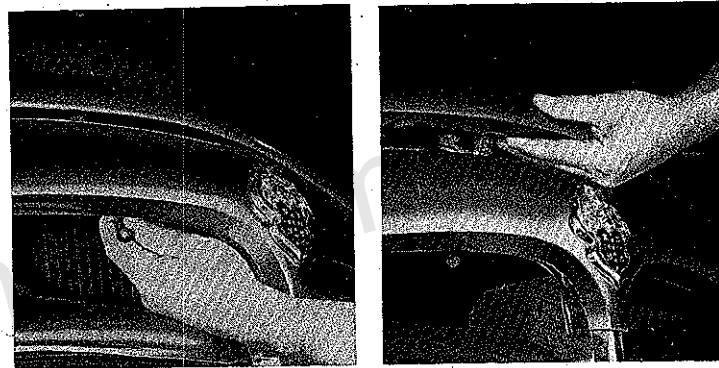

### *Trunk*

The bonnet release lever is located at the front of the car, at the upper right side of the center grille bar. The bonnet lock can be released by reaching under the radiator grille upper bar and pulling the lever forward. This will permit the bonnet to lift high enough so the safety catch, which is located under the front edge of the bonnet directly above the center grille bar, can be released. The safety catch is released by pulling it upward and raising the front end of the bonnet at the same time. Spring loaded hinges assist in raising the bonnet and hold it in its fully open position.

The bonnet will lock automatically when lowered and gently pushed downward.

### *Bonnet*

ASK THE  
MAN WHO  
OWNS ONE

## Power Steering

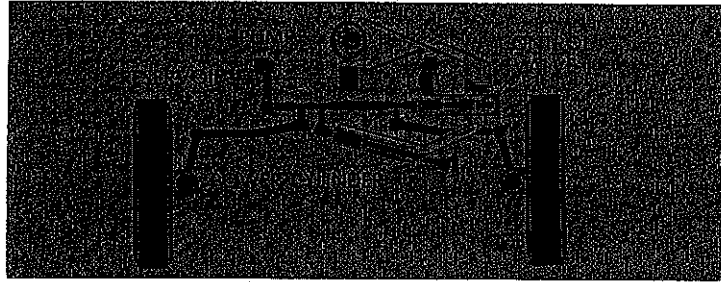

The new Packard Power Steering, which is operated hydraulically, greatly reduces the physical effort of the driver—thereby resulting in more restful driving and greater ease of parking. With Packard Power Steering approximately 80% of the required steering effort is supplied by the hydraulic mechanism.

One of the greatest causes of driving fatigue is road shock, which usually occurs when driving on rough roads. This, of course, is transmitted through the steering linkage, and steering gear, to the steering wheel. With Packard Power Steering road shock is eliminated. The Packard Power Steering unit counteracts road shock automatically.

The Packard Power Steering system consists of a hydraulic pump to supply hydraulic pressure; a reservoir in which fluid is held in reserve for operating the power system; a control valve and linkage in which the valve directs the flow of hydraulic pressure to the power cylinder, which operates the steering linkage in accordance with the driver's intention to turn; and the necessary hoses for transmitting the hydraulic pressure. The system also incorporates a safety factor which permits normal mechanical steering control in the event the power system becomes inoperative.

The Packard Power Steering requires no attention except the usual lubrication of steering linkage and the checking of the fluid.

Control your comfort by the simple operation of two levers and a switch, located on the instrument panel at the right of the steering column. They will regulate the flow of fresh air to the exact amount that you find comfortable.

Every Packard is equipped with a built-in ventilating system that is designed to provide a complete change of air every 45 seconds at 40 MPH.

— Ventilation is regulated by sliding the left lever down to permit the flow of air through the left dash panel grille at your feet. Operating the right lever in the same way will regulate the flow of air through the right side dash panel grille.

“OFF”—Fresh air supply completely closed off.

“AIR”—Wide open or, in other words, a full flow of fresh air.

Positions between “OFF” and “AIR” can be used to reduce or increase the flow of air as desired.

The remaining lever positions are not used unless the car is equipped with heater and defroster.

The fresh air heater and defroster equipment is available for all Packard cars as an accessory. This system operates along with the built-in ventilation system to provide comfortable, even temperatures inside the car as well as clear-across windshield defrosting.

Accurate temperature regulation is achieved by operating the left lever. The flow of warm air that passes through the windshield defroster and heat outlets is regulated by operating the right lever.

When the *left lever* is moved below “AIR” position into the range marked “THERMOSTAT” it closes off the left side air supply and becomes a temperature regulator. The temperature is increased as the lever is lowered.

When the *right lever* is moved below “AIR” position it closes off the air supply through the right dash panel grille and directs it into a compartment where it is heated for distribution either to the inside of the windshield or toward the floor of the front compart-

Heating  
Ventilating  
System



Warm  
weather

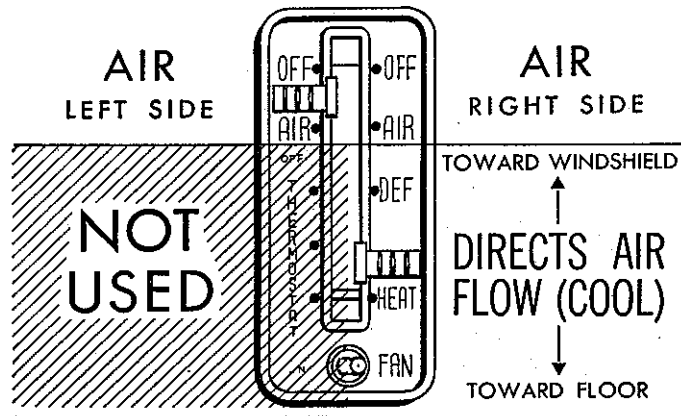

Cold  
weather

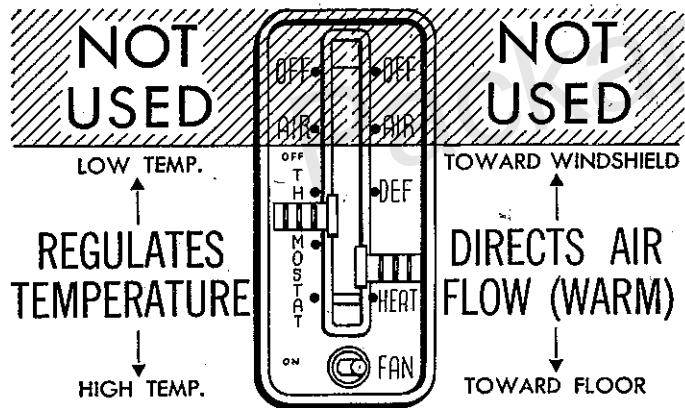

ment as desired. With the lever at "DEF," all the heated air is directed against the windshield.

With the lever at "HEAT" all the heated air is directed toward the front compartment floor.

Lever positions between "DEF" and "HEAT" may be used to divide the flow of air as desired.

The "FAN" switch controls a blower which draws in outside air for circulation through the heating and defrosting outlets. It is not necessary to use the blower fan for most normal driving conditions because enough air usually is forced into the system by the forward motion of the car. The fan generally is used to speed up defrosting of the windshield or to prevent windshield and window fogging while driving slowly.

The "Clipper" models are equipped with a single-speed toggle switch which, when moved toward the left to "ON", starts the blower fan.

The "300" and "400" models are equipped with a two-speed switch having a pointer type knob. The switch is in its off position when the control knob is turned fully to the left (Counterclockwise) with the pointer pointing downward. The blower fan will run at high speed when the knob is turned to the right (Clockwise) when a notch or detent is reached in the switch. The blower fan will run at low speed when the knob is turned past the notch and fully to the right.

The ultimate in automatic transmissions is yours exclusively in a Packard. Ultramatic Drive, which was perfected after years of research and development by Packard, is one of today's finest engineering achievements. You drive Ultramatically, without pushing clutch pedals or shifting gears, by simply positioning the control lever and "stepping on the gas."

"H" means HIGH range. This position is used for all normal forward driving. When driving below 50 miles per hour in the high range, an extra burst of power for quick passing of another car can be had by pressing the accelerator pedal firmly down against the floor. The high

Ultramatic  
Drive

ASK THE  
MAN WHO  
OWNS ONE

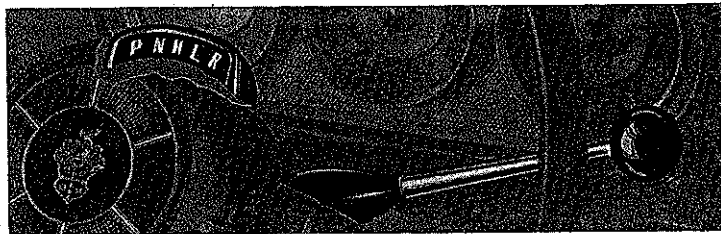

range position normally is used when starting on ice or in snow when gradual rear wheel traction is desired.

"L" means LOW range. Low range is used in deep sand and on long, hard pulls. It also should be used when going up or down steep grades. Driving down a steep grade in low range lets the engine act as a brake to reduce car speed.

"R" is for REVERSE. The control lever must be raised before it can be pulled downward into the reverse position.

"N" is for NEUTRAL. This position is used when the car is standing with the engine running. In the neutral position, the engine may be speeded up without moving the car.

"P" means PARK. The rear wheels are not free to turn when the control lever is in the parking position and this position should be used when parking on a hill. The control lever NEVER should be placed in the parking position while the car is moving. The lever must be raised before it can be pushed upward into the parking position.

The engine, in cars with Ultramatic Drive, can be started only if the control lever is in the neutral position "N" or the parking position "P." The starting motor will not operate if the lever is in any other position.

The engine usually is started with the control lever in the neutral position. In extremely cold climates, especially after the car has been

standing for a long time, the engine should be started with the lever in the parking position. This will prevent creeping which is caused by extremely cold fluid in the unit.

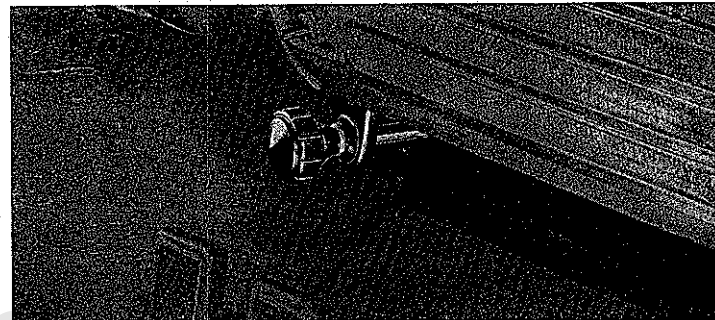

Packard's overdrive operates along with the manual-shift transmission to provide a fourth forward speed or cruising range. This saves gasoline because the engine runs slower at a given car speed, as compared to the speed it would have to run in high gear without an overdrive.

The overdrive control knob is used to lock in or to lock out the overdrive as desired.

When the knob is pulled all the way out, the overdrive is locked out and the cruising range cannot be used.

When the knob is all the way in, the overdrive cruising range is ready for use after the car speed reaches approximately 22 miles per hour. Just lift your foot from the accelerator pedal for a moment and then depress the accelerator. The overdrive will shift into cruising range automatically while your foot is off the pedal. The overdrive also will shift back to conventional high gear automatically when the car speed drops below approximately 17 miles per hour.

Overdrive

ing the  
e (with  
ramatic  
Drive)



While cruising along in overdrive, you may want a sudden burst of power to pass another car. If so, push the accelerator pedal firmly to the floor to shift back into conventional high gear. After passing, lift your foot from the accelerator pedal to automatically shift into overdrive or cruising range again.

The overdrive can be made available for operation at any speed just by pushing the control knob all the way in.

There are two things to remember if you want to lock out the overdrive: (1) to lock it out while in high gear below approximately 22 miles per hour, press lightly on the accelerator pedal and pull out the control knob, (2) to lock it out while in overdrive above approximately 22 miles per hour, press the accelerator pedal firmly to the floor to shift back to conventional high gear and then pull out the knob.

It is advisable to lock out the overdrive when driving on icy or slippery roads and when driving down steep grades. This will let the engine act as a brake to reduce car speed.

Packard Service as rendered by Authorized Packard Dealers specializes in safety service and in preventive service for the protection of your Packard investment and the safe and economical operation of your car for many thousands of miles.

Periodic lubrication and inspection provide smooth operation and long car life. Ask your Dealer about the convenient low cost Packard Lubrication-Inspection Plans. Use Authorized Packard Service. It's best for your Packard. It assures the use of Packard Parts, Packard special tools and equipment by factory trained Packard Master Servicemen.

Different types of engine oil are made to meet the various needs of everyday driving. These are defined as follows:

The REGULAR OR ML TYPE designates engine oil generally suitable for use in internal combustion engines under moderate operating conditions.

The PREMIUM OR MM TYPE designates engine oil having the oxidation stability and bearing corrosion preventive properties necessary to make it generally suitable for use in internal combustion engines where operating conditions are more severe than regular duty.

Both types of oil are available in several grades.

During the first 500 miles, use the oil that was in the engine when the car was delivered. If it is necessary to add oil during this period, use nothing heavier than S.A.E. 10-W oil in cold weather and S.A.E. 20 or 20-W in warm weather.

After the first 500 miles, oil should be selected to meet different driving and climatic conditions.

During warm weather, use S.A.E. 20 engine oil; however, if the car is regularly driven at high speeds or if the average daylight temperature is above 90°F., use S.A.E. 30 oil.

The "OIL GRADE AND TEMPERATURE CHART" lists the oil grades to use during cold weather. If there is any doubt as to which grade of oil to use, consult your Packard Dealer; he will assist you in selecting the proper grade.

#### OIL GRADE AND TEMPERATURE CHART

IF THE ANTICIPATED MINIMUM ATMOSPHERIC TEMPERATURE WILL BE:	USE THE GRADE INDICATED:
Not lower than 32°F. above zero.....	S.A.E. 20 or 20-W
As low as 10°F. above zero.....	20-W
As low as 10°F. below zero.....	10-W
Below 10°F. below zero.....	5-W

Select  
Engine

Lubrication

Types of  
Engine Oil

ASK THE  
MAN WHO  
OWNS ON

# ication Chart

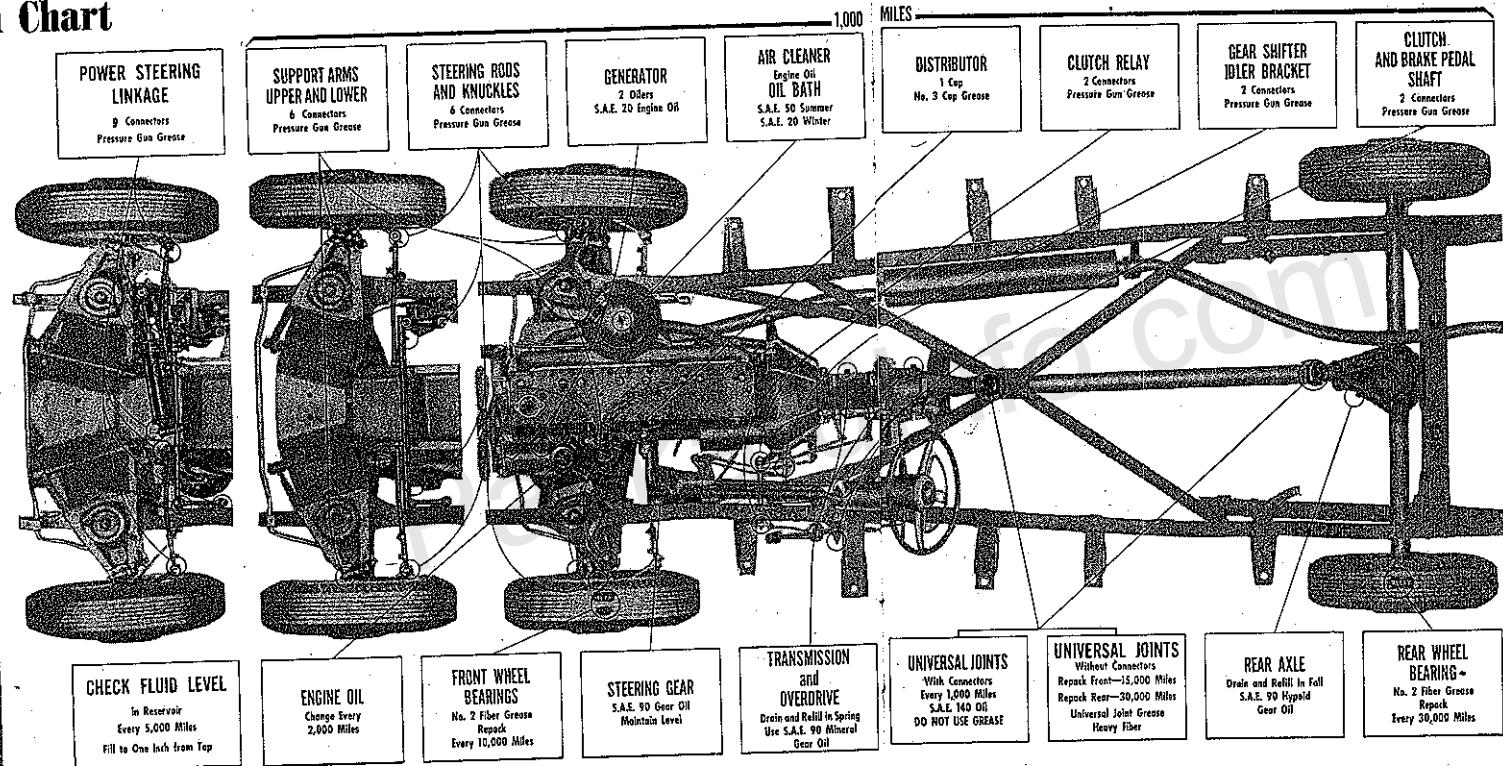

## SERVICING THE ULTRAMATIC DRIVE

CHECK THE FLUID LEVEL EVERY 1,000 MILES



CHANGE FLUID REMOVE SCREEN AND CLEAN EVERY 25,000 MILES



CONVERTER DRAIN OR PAN DRAIN

CURVED SPOUT FILTER

REFILL WITH PACKARD ULTRAMATIC DRIVE FLUID



## Engine Oil Level

The engine oil level should be checked every time gasoline is purchased. Two level marks are stamped on the oil stick, one marked "LOW" and the other marked "FULL." The oil level should be maintained between these marks. Never permit the oil level to get below the "LOW" mark and, when necessary, add only enough oil to bring the level up to the "FULL" mark. Always check the oil level before starting on a long drive.

## Special Engine Oils

"Break-in" oils or compounds which are added to the engine oil are unnecessary. They should not be used under any circumstances unless the supplier can furnish satisfactory proof that they contain no harmful ingredients.

## Changing Engine Oil

It is recommended that the engine oil be changed every 2,000 miles if the car is operated under normal driving and climatic conditions. However, it may be necessary to change the oil more frequently if the following conditions prevail:

1. **DUST.** When driving through dust storms or on very dusty roads dust may get into the engine oil in spite of the engine air cleaners.
2. **COLD WEATHER.** Frequent starts and short runs in cold weather do not permit the engine to warm up thoroughly and water may get into the oil from condensation of moisture.
3. **HARD DRIVING.** Hard driving and heat tend to thicken the oil and this may interfere with easy starting in cold weather.

## Air Cleaners

The mesh in the combination oil filler cap and air cleaner should be cleaned and re-oiled each time the engine oil is changed. Clean the mesh by swishing the filler cap in gasoline, shake dry, and then dip it in clean engine oil.

The mesh type carburetor air cleaners also should be cleaned and re-oiled at each engine oil change. After the mesh has been cleaned in gasoline, re-oil it with engine oil using an oil can.

The heavy duty oil bath cleaner oil should be changed and the oil reservoir cleaned every 5,000 miles or oftener if driving conditions warrant. When refilling, use approximately one pint of S.A.E. 50 engine oil in warm weather and S.A.E. 20 in cold weather.

The air cleaner used with the Easamatic Power Brake should be replaced every 10,000 miles.

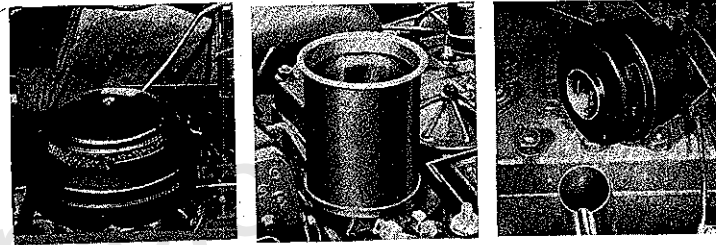

The oil level in the reservoir should be checked after the first 1,000 miles of driving and every 5,000 miles thereafter, and maintained to within 1" from the top of the reservoir.

Packard Ultramatic Drive fluid, which is available at all Packard Dealers, should be used for the power steering hydraulic system. If this fluid is not available any "A" type automatic transmission fluid may be used which has an AQ-ATF number embossed on the top of the can.

The transmission, and the overdrive if the car is so equipped, is to be lubricated with a multi-purpose gear oil of S.A.E. 90 viscosity. If difficulty in gear shifting is experienced during extremely cold weather, use S.A.E. 80 multi-purpose gear oil.

The oil level should be checked every 1,000 miles and oil added if necessary. The oil should be drained and replaced with fresh oil each spring.

## Power Oil

## Transmission Oil





*Automatic  
Fluid*

The fluid level in the Ultramatic Drive unit should be checked every 1,000 miles and, if necessary, fluid added to maintain the level at the full mark on the dip stick.

Every 25,000 miles the unit should be drained, oil screen cleaned, and the unit refilled with new oil.

Packard Ultramatic Drive Fluid, obtainable at Packard Dealers, should be used or any type "A" automatic transmission fluid which has an AQ-ATF number embossed on the top of the can may be used.

It is recommended that the Packard Ultramatic Drive be serviced by Authorized Packard Service Stations.

*Axle  
Lubricant*

The rear axle is to be lubricated with S.A.E. 90 Hypoid Lubricant. S.A.E. 80 Hypoid Lubricant should be used where the temperature drops to 10 degrees or more below zero for long periods of time.

The level should be checked every 1,000 miles and Hypoid Lubricant added if required. The axle should be drained and refilled with fresh Hypoid Lubricant each fall with the approach of cold weather.

*Universal  
Joints*

All 26th Series Packards equipped with Ultramatic Drive use a propeller shaft with a ball and trunnion type front universal joint which requires repacking at 15,000 mile intervals with a heavy fiber universal joint grease. The cross-type rear universal joint requires repacking at 30,000 mile intervals with a heavy fiber universal joint grease having extreme pressure characteristics.

Cars having the manual shift transmissions are equipped with universal joints having oil fittings and these universal joints should be lubricated with S.A.E. 140 gear oil every 1,000 miles. Chassis lubricant never should be used in these joints.

*Brings*

The rear springs of your car should not be lubricated. Liners are installed between the spring leaves to control the spring action and grease

or oil is harmful to these liners. Should a squeak develop in the rear springs, do not have them lubricated. Consult a Packard Dealer for correction.

Detailed instructions for lubrication are listed and illustrated in the "Lubrication Chart." All chassis lubricating points require attention every 1,000 miles.

Following are several items of lubrication and maintenance regularly required which are emphasized here for your convenience.

### PERIODIC OPERATIONS

Front wheel bearings.....	Repack every 10,000 miles
Rear wheel bearings.....	Repack every 30,000 miles
Oil filter (when used).....	Renew cartridge every 8,000 miles
Brakes.....	Check fluid level every 1,000 miles
Cooling system.....	Flush twice a year—spring and fall
Gasoline lines and strainers.....	Clean out twice a year—spring and fall
Engine oil pan.....	Remove and clean once a year
Ultramatic oil screen.....	Remove and clean every 25,000 miles

Your Packard has a sealed, pressure type cooling system to provide the best cooling possible. This pressure is made possible by the use of a special radiator cap.

Without pressure in the system, water would boil at 212°F.; however, in the Packard pressure type system, this boiling point is raised to approximately 233°F.

*Chassis*

*Season  
and Pe  
Operat*

**Cooling  
System**

ASK THE  
MAN WHO  
OWNS ONE

**CAUTION**

When removing the radiator cap while the engine is hot, first loosen the cap to the first notch and allow the pressure in the radiator to escape before completely removing the cap.

**Level**

The system requires regular attention. The coolant level in the radiator should be kept at about one inch below the bottom of the filler neck. If coolant is added above this level, it will flow out of the radiator vent after the engine has warmed up.

**NOTE**

If for some reason the water in the radiator should get very low and the engine very hot, let the engine cool off before adding cold water. After the engine has cooled off, add the water slowly with the engine running. Cold water in a very hot engine might crack the cylinder block or head.

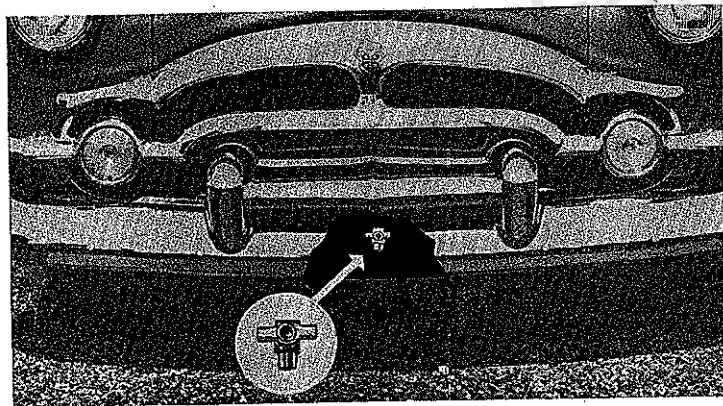

The cooling system should be drained and flushed twice a year. To completely drain the system, first remove the radiator cap and then open the radiator drain cock behind the front bumper near the center of the car and remove the plug from the cylinder block near the starter.

Packard Rust Preventive, available through your Packard Dealer, is a special solution that cuts down the formation of scale and rust. Packard Rust Preventive should be added at least twice a year or whenever the cooling system is drained for any reason. This inexpensive service can save you dollars in repairs at some later date.

Among the anti-freeze solutions that have been found satisfactory are those made from ethylene glycol (permanent type), denatured ethyl alcohol (ethanol) and methyl or wood alcohol (methanol). Your Packard Dealer can supply Packard Permanent Type Anti-Freeze (ethylene glycol), a factory approved product.

Kerosene or other oils, or solutions containing calcium chloride, magnesium chloride, sodium silicate or other inorganic salts, honey, glucose, or sugar are not satisfactory for use in the cooling system, and should not be used.

Before installing anti-freeze solution, the cooling system should be inspected and serviced for winter operation. After the anti-freeze has been installed, the entire system, including the hose connections, cylinder head gasket, and the water pump should be inspected regularly to make sure that no leaks have developed.

The cooling system capacity of your Packard is 20 quarts. If the car is equipped with heater and defroster, the capacity is approximately 20½ quarts. The following table shows the amount of anti-freeze solution required to protect your car down to the temperature indicated.

*Drain  
the Sys*

*Rust  
Preven*

*Anti-F*

*Anti-F  
Chart*

## ANTI-FREEZE CHART

COOLING SYSTEM CAPACITY	FOR PROTECTION DOWN TO	QUARTS ETHYLENE GLYCOL	QUARTS ALCOHOL
20 Quarts	Zero Fahrenheit	7	7
	10° Below Zero Fahrenheit	8	9
	20° Below Zero Fahrenheit	9	10

The life of your battery depends upon the care it receives. The water level should be checked every 1,000 miles or every two weeks in warm weather and once a month in cold weather and distilled water added when necessary.

When filling the battery, the electrolyte (the fluid in the battery) should not be allowed to overflow because it is very corrosive. Should this happen, however, the battery fluid should be washed away with a solution of bicarbonate of soda and then rinsed.

If the battery requires a considerable amount of water, the electrical system may not be operating properly and you should consult your Packard Dealer for correction.

If your car is to be stored for a period of more than a month, have the battery removed by your Packard Dealer so that it will be properly serviced and kept in a healthy state of charge.

Do not add battery dopes or any chemicals, oils, or other substances to your battery because they reduce battery life. (This also will void the battery warranty.)

**CAUTION** Never allow a flame or spark near the battery because gas produced within the battery may be ignited and explode.

## LIGHT BULB CHART

LOCATION	CANDLE-POWER	MFR. NO.
Courtesy and Map Lights.....	6	82
Glove Box Light.....	2	55
Headlights.....	35-45 Watt	—
Ignition Switch.....	2	55
Indicator Light Bulbs.....		
Headlight High Beam.....	1	51
Direction Signal.....	2	55
Oil Pressure.....	2	55
Battery Discharge.....	2	55
Selector Lever (Ultramatic).....	1	51
Instrument Lights.....	2	55
License Lights.....	3	63
Parking and Direction Signal Light (Front).....	3-21	1154
Reading Lights (Dome).....	15	210
Stop and Tail Lights.....	21-3	1154
Models Cavalier and Patrician.....	21-3 and 3	1154 and 63
Trunk Light.....	6	81
Back Up Lights—Cavalier and Patrician.....	32	1133

## FUSE AND CIRCUIT BREAKER CHART

CIRCUIT	LOCATION	CAP. AMPS.	NO.
Clock	In cable at rear of clock.....	3	AGA-3
Direction Sig. Flasher	{ Circuit breaker on instrument cluster.....	10	—
Radio	In cable on left side of radio.....	14	SFE-14
Overdrive	On relay on dash panel.....	30	SFE-30
Heater	In cable near ignition switch.....	20	SFE-20
Head, Tail and Parking Lights	{ Circuit breaker on headlight switch.....	30	—
Body Wiring	Circuit Bkr. on Inst. Cluster.....	30	—
Glove Box Light	} Circuit Bkr. on Inst. Cluster.....	30	—
Stop Light Circuit			

## Headlights

Your Packard is equipped with the finest "Sealed Beam" headlights built today. The only services required are wiping off the lenses, checking aim periodically, and replacing the unit in case it burns out or becomes damaged.

It is recommended that the car be taken to an Authorized Packard Service Station every six months to have the aim of the headlights checked. Your Packard Dealer has the equipment to do this aiming job properly and quickly.

Having the proper amount of air in the tires at all times is most important if high tire mileage and a satisfactory ride are to be obtained. Too much air will adversely affect the ride, while not enough air will cause tire wear.

Tires should be checked every week or ten days and inflated to the proper pressure. When touring or driving several hundred miles a day, check the tire pressure every day or two. Always reinstall the tire valve caps because they keep out dirt and seal the valve opening.

The recommended cold or starting tire pressure is 24 pounds for both the front and the rear tires.

After the car has been driven at normal speeds in the city, the pressure should be 27 pounds (3 pounds over the starting pressure of 24 pounds).

After driving on the highway at moderately high or high speeds, the pressure should be 29 pounds (5 pounds over the starting pressure).

Never bleed the tires to reduce the pressure built up by heat. The tires are designed to build up a safe pressure of a few pounds after they are run.

The carefully balanced, demountable, drop center, disc-type wheels incorporate a safety feature in the form of a raised ridge, or section, between the rim flange and the drop center of the wheel rim. This ridge

tends to keep the tire bead tightly against the rim flange, even in case of a sudden deflation of the tire.

When inflating the tires, the air pressure within the tube snaps the bead over the ridge and holds it tightly against the rim flange. When removing the tire from the rim, additional force is required to push the tire bead over the ridge into the drop center. This can be accomplished by using the car jack under the bumper.

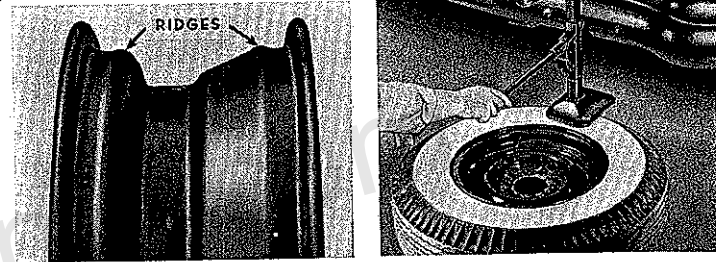

Cross switching the wheels and tires every 3,000 to 4,000 miles greatly increases tire life. By doing this, all five tires will get the same amount of wear over a given period.

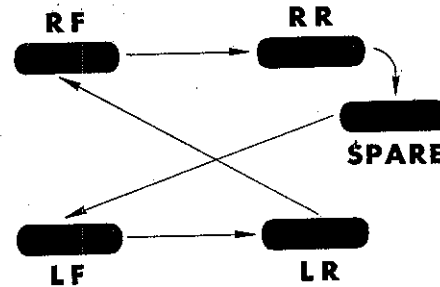

Cross-  
Tires

## Wheels and Tires

### Pressure

### Safety Rim Wheels



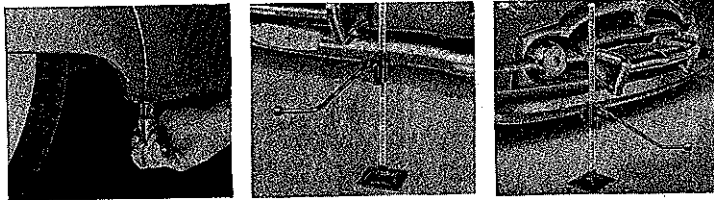

Changing  
Wheels

Emergency wheel changing in case of flat tire is most easily accomplished by the following procedure:

If a rear wheel is to be changed, the wheel shield is removed by removing the screw at the rear of the shield using the wrench furnished in the tool kit. The shield will then drop down at the rear and can be swung clear of the fender.

Make sure the hand brake is set.

Remove the hub cap, using the flattened end of the combination wheel wrench and jack handle as a pry.

Loosen the wheel mounting bolts not more than a turn or two.

Assemble the jack to its base and place the jack under the bumper bar directly between the two bolt heads in the bumper, behind the wheel to be changed. Be sure the jack bar is in a vertical position before attempting to lift the car.

Raise the car to a height just sufficient to remove the wheel.

Remove the wheel retaining bolts and lift off the wheel and tire.

Install the spare wheel by reversing the foregoing operations.

To install the wheel shield, engage the projecting dowel located on the lower front corner of the shield into its respective hole in the fender. Swing the shield upward into place engaging the remaining dowels in their respective holes. Install the retaining screw at the rear of the shield and tighten with the wrench.

If a front wheel is to be changed, locate the jack under the front bumper between the bolt heads as illustrated.

The Packard engine has been designed to give quick, easy starting even in the coldest weather.

When starting the engine, always disengage the clutch on non-Ultramatic Drive equipped cars by holding the clutch pedal down until the engine has started. The starting motor then can turn the engine over without having to turn the transmission gears along with the engine. The additional load of turning the transmission gears is especially high in cold weather when the transmission oil is cold and thick.

Turn the ignition key to the right and then slowly press down on the accelerator pedal just far enough to engage the starter. Release the accelerator pedal as soon as the engine starts. Do not race the engine during the warm-up period.

If the engine does not start within a reasonable length of time, it may be over-choked or flooded. If so, press the accelerator pedal slowly to the floor and hold it there until the engine starts.

*Never start or run an engine in a closed garage. Exhaust gases from gasoline engines contain carbon monoxide gas—a deadly poison gas which gives no warning of its presence . . . it is colorless and odorless.*

#### CAUTION

Your 26th Series Packard has a high compression engine and it is recommended that the engine be operated on premium fuels.

Occasionally Ultramatic Drive equipped vehicles are pushed to start the engine or, if disabled as the result of a collision, are towed into a Packard Dealer's service station.

If it is necessary to push the car to start the engine, which sometimes is done if the battery is weak, the selector lever should be placed in the neutral position, "N", and the ignition switch turned on. When the

Driving  
New Car

Starting  
Engine

The Right  
Gasoline

Pushing or  
Towing  
Ultramatic  
Drive

ASK THE  
MAN WHO  
OWNS ONE

car reaches a speed of 25 miles per hour, the selector lever should be moved to the high range position, "H", at which time the engine will turn over.

A disabled vehicle may be towed on the rear wheels if the Ultramatic Drive unit is not damaged and no oil has been lost: however, the selector lever *must* be placed in the *neutral* "N" position. If the selector lever is in any other position, unnecessary damage may result. Towing speed should be limited to 30 miles per hour and long distance towing (over 300 miles) is not recommended.

Sometimes a collision may damage the shift linkage to the extent that the selector lever cannot be shifted to the neutral, "N", position. In this event, the propeller shaft should be removed or the car should be towed in with the rear wheels raised off the pavement. This procedure also should be followed if the transmission is damaged, the transmission oil pan distorted, or when oil is lost.

No special instructions apply to pushing or towing the car when it is equipped with an overdrive. However, if the car is being pushed to start the engine, the overdrive should be locked out.

In most cases the overdrive can be locked out while the car is standing just by pulling out the lockout knob. If the knob cannot be pulled all the way out, move the car forward or backward slightly and pull out on the knob.

The manner in which your new car is driven for the first 250 miles has much to do with the way it will operate at a later date. This applies to the brakes, gears, rear axle, as well as to the engine and other units.

During this period it is not recommended to open the throttle wide for acceleration or hill climbing and the speed should not exceed 50 miles per hour. In the long run, this will pay off in many additional thousands of miles of motoring pleasure.

The driver who makes a fast getaway from traffic lights before getting into direct drive or high gear will find this form of driving expensive.

These fast starts waste gasoline and will cause undue wear even on the best of parts. The driver who gets into direct drive or high gear at moderate speeds will save on both gasoline and service expense.

Maintaining a steady speed on the highway will save gasoline. A steady accelerator pedal will always result in more miles per gallon than one which is continually being operated up and down for passing other cars, for curves, and for intersections.

When any car engine is started in cold weather, it needs more gasoline to run smoothly without stopping than it does after it is warmed up. It also is true that the engine will warm up faster while the car is standing than it will while moving. Do not operate a cold engine at excessively high speeds.

The good driver makes it a habit to let the engine warm up for a minute or two before starting to drive in cold weather.

Safe driving is careful, not timid but competent driving. It requires concentration and courtesy.

The competent driver is always sure of his car. He knows what it will do when he accelerates. He knows what it will do when he decelerates. He drives so he can stop within a clear distance ahead. He has his car under control at all times.

He keeps his brakes adjusted so he knows what he can expect when he wants to stop. His tires and battery are checked at proper intervals. He always takes traffic, pavement, visibility and weather conditions into consideration.

If your car is equipped with Ultramatic Drive, never shift it from "high" to "neutral" and coast as the car is then not under the driver's complete control. This practice will both abuse the transmission and

*Starting  
a Stop*

*Driving  
Highway*

*Warm  
Cold*

*Safe D  
Tips*

*ing or  
(with  
drive)*

*Break-in  
Period*



cause abnormal wear on the brakes, and actual saving on gasoline will be negligible.

A good driver keeps his windshield and rear view mirror clean and his windshield wipers and lights in good working order and adjusted. He signals his turns and stops, slows down for schools and cross roads, watches railroad crossings, and never passes on hills, curves, or crossings. He also stops for all school busses.

A good driver exercises due regard for the rights of others and assumes responsibility for the safety of pedestrians and playing children.

After parking your car always remove the keys from the ignition lock if the car is going to be unattended even for only a few moments. By following this practice you will eliminate the possibility of the car being stolen.

When driving in the mountains or hilly country where steep grades are encountered and the car is equipped with overdrive, it should be locked out to provide better control of the car. This can be done when the car is standing or the car speed is below that of 17 miles per hour. This will utilize the engine for braking power when descending steep grades.

On Ultramatic Drive equipped cars, when descending steep grades in the mountains and hills, the car should be driven in "LOW" range to utilize the braking power of the engine. The shift to low range should not be attempted unless the car is stopped or the speed is below 25 miles per hour.

Test reports show that cars in normal satisfactory operating condition will give good gas economy at 20, 30 or 40 miles per hour, yet the economy drops off sharply between 40 and 50 miles per hour. In fact, in some cases the gas economy is as much as almost 2 miles per gallon better at 40 MPH than at 50 MPH. The gas economy drops off approximately another 2 miles per gallon when driving 60 MPH. and another 2 miles per gallon at 70 MPH. Another factor affecting gas economy is

frequent stops and starts, which happens mostly when driving in heavy traffic and sudden acceleration. It has been established that one of the causes of poor gas economy is due to poor driving habits of the owner or driving conditions. However, if this is not the cause, the following factors will contribute toward poor fuel economy:

1. Inefficient spark plugs
2. Bad distributor points
3. Gum deposits in carburetor
4. Engine running too cold
5. Dragging brakes
6. Low tire pressure
7. Leaky intake manifold gasket
8. Restricted air cleaner
9. Motor oil too heavy

A combustion analysis by your Packard Dealer will determine if the carburetor or fuel system is at fault. Periodic tune-ups in which many important adjustments are made will have a direct bearing on operating economy.

Fine dust may be safely removed by dusting with a soft, clean cloth, but "scrubbing" a dirty car with dry cloths is almost certain to scratch it.

Clean the car by washing with plenty of cold or luke-warm water. Soak the dirt off as much as possible and rinse sponges frequently to remove grit and dirt. Dry with a clean chamois. Avoid washing the car in the sun or when the lacquered surfaces are hot. Never use hot water.

In sections where salt, calcium chloride, or similar chemicals are used on the roads, frequent washing of the car is necessary to preserve the finish. Where cars are to be exposed to freezing temperatures immediately after washing, all water must be removed from the lock cylinders and the edges of the doors and adjustable windows to prevent sticking due to the formation of ice.

A high luster can be restored with a Packard Lustur-Seal Treatment (available at your Packard Dealer) or any other properly formulated body polish. The presence of color on the rubbing cloths simply indicates the removal of chalked or dead surface pigment loosened by exposure.

Any lacquered surface upon which alcohol solutions have been spilled should immediately be flushed with water.

### Glass

Plate glass although hard can quite easily be scratched. Cleaning a dirty windshield when dry by operation of the wiper blades or with dry cloths is apt to cause minute surface scratches. Wet glass before cleaning.

### Chromium Plating

Among the more common elements that attack chromium plating are: sulphur dioxide present in the air, especially in large industrial centers; calcium chloride used on city streets to melt ice and on dirt roads to prevent dust; also the salt air of coastal territories. When plating is scratched or scuffed to the base metal, ordinary moisture becomes a corrosive agent. Rust, originating at the root of a scratch, will continue to spread underneath the plating unless attended to when it first appears.

*Due to present material shortages caused by the national emergency, we the Manufacturer, are supplying chrome in accordance with Government regulations. For proper care and protection of this chrome, see your Packard Dealer.*

### Upholstery

Where the use of cleaning fluid is indicated, use Packard Fabric Cleaner or a cleaning fluid in which carbon tetrachloride is the principal ingredient. To avoid rings, work from the outside toward the center.

**BATTERY ACID** will destroy upholstery if allowed to remain. Neutralize the acid as soon as possible by pouring household ammonia water directly on the spot to saturate the fabric as far as the acid extends. Give the ammonia water a full minute to neutralize the acid and then sponge the fabric with a wet cloth. Use cold water.

**BLOOD STAINS**, rub with a clean cloth wet with cold water.

**CANDY OR FRUIT** stains should be rubbed with a clean cloth wet with very hot water. If chocolate is present in the candy stain, use lukewarm water. After drying, sponge with a clean cloth wet with cleaning fluid.

**GUM**, moisten with cleaning fluid; remove with a dull knife.

**ICE CREAM**, rub with a clean cloth wet with very hot water. If this is not satisfactory, use a cloth wet with warm soap suds and rinse with a cloth wet with cold water. After drying, sponge with cleaning fluid.

**LIPSTICK**, pour cleaning fluid directly on spot and immediately hold a clean blotter on stain. Repeat until clean.

**SHOE POLISH**, for black or tan polish, use a cloth wet with cleaning fluid. If white polish cannot be brushed off, wet with cold water, allow to dry, and then brush off.

**GREASE OR OIL**, small spots should be rubbed with a cloth wet with cleaning fluid. Pour cleaning fluid on large spots and blot with clean blotters.

**TAR**, moisten with cleaning fluid and remove with a dull knife. Sponge with cloth wet with cleaning fluid.

**PAINTS AND LACQUER**, rub with a cloth wet with turpentine and then sponge with a cloth wet with cold water.

**WATER SPOTS**, sponge the entire panel with a cloth dampened with cold water; then sponge the spots with a cloth moistened with cleaning fluid.

Packard Fabric Cleaner or common upholstery cleaners, such as naphtha, carbon tetrachloride, etc., may be used for removing spots from top material. Do not use dry or damp cloth to clean rear window panel. Flush with clean, cold water to remove dust, etc. If further cleaning is required, lather panel with mild soapsuds, using palm of hand, and then rinse thoroughly.

### CAUTION

Before lowering top, unzip rear window panel at the sides and top and drop it into top compartment.

Upholstery  
(continued)

Conversion  
and  
Rear





Model	Clipper	Clipper Deluxe	Mayfair & Convertible
Chassis Symbols	2601	2611	2631

**ENGINE**

Type.....	8 Cyl. "L" Head	8 Cyl. "L" Head	8 Cyl. "L" Head
Bore.....	3½"	3½"	3½"
Stroke.....	3¾"	4¼"	4¼"
A.M.A. Horsepower.....	39.2	39.2	39.2
Oil Capacity.....	7 qt.	7 qt.	7 qt.
Water Capacity.....	20 qt.	20 qt.	20 qt.
Heater Capacity.....	½ qt.	½ qt.	½ qt.
Thermostat Rating			
Standard.....	170°	170°	170°
Fuel Tank.....	20 gal.	20 gal.	20 gal.
Valve Clearance			
Intake—Hot.....	0.007"	0.007"	Hydraulic
Exhaust—Hot.....	0.010"	0.010"	Hydraulic

**COMPRESSION RATIO**

Compression.....	7.7 to 1	8.0 to 1	8.0 to 1
------------------	----------	----------	----------

**BRAKE HORSEPOWER**

Brake HP.....	150 @ 4000 RPM	160 @ 3600 RPM	180 @ 4000 RPM
---------------	----------------	----------------	----------------

**ELECTRICAL**

Battery.....	17 Plate—100 hr.	17 Plate—100 hr.	17 Plate—100 hr.
Generator.....	45 Amp. Shunt	45 Amp. Shunt	45 Amp. Shunt
Regulator.....	Voltage & Current Control	Voltage & Current Control	Voltage & Current Control
Ign. Point Gap.....	0.016"	0.016"	0.016"
Spark Plugs.....	14 mm.	14 mm.	14 mm.
Spark Plug Gap.....	0.025"	0.025"	0.025"
Ignition Timing.....	6° btdc	6° btdc	6° btdc
Headlights.....	Sealed Beam	Sealed Beam	Sealed Beam

**TRANSMISSION**

Type.....	Selective Silent Synchronized	Selective Silent Synchronized	Selective Silent Synchronized
Oil Capacity.....	2 pt.	2 pt.	2 pt.
Overdrive Capacity.....	1¼ pt.	1¼ pt.	1¼ pt.
Total Capacity.....	3¼ pt.	3¼ pt.	3¼ pt.

Model	Clipper	Clipper Deluxe	Mayfair & Convertible
Chassis Symbols	2601	2611	2631

**CLUTCH**

Type.....	Dry Disc 10"	Dry Disc 10½"	Dry Disc 10½"
Clutch Pedal Free Play.....	1¼" to 1½"	1¼" to 1½"	1¼" to 1½"

**REAR AXLE**

Type.....	Hypoid	Hypoid	Hypoid
Oil Capacity.....	4¼ pt.	4¼ pt.	4¼ pt.
Ratio			
Standard.....	3.9 to 1	3.9 to 1	3.9 to 1
Overdrive.....	4.1 to 1	4.1 to 1	4.1 to 1
Ultramatic Drive.....	3.54 to 1	3.23 to 1	3.54 to 1

**SUSPENSION**

Type.....	Independent Parallelogram	Independent Parallelogram	Independent Parallelogram
Springs			
Front.....	Coil	Coil	Coil
Rear.....	Leaf	Leaf	Leaf
Shock Absorbers			
Front & Rear.....	Direct Acting	Direct Acting	Direct Acting

**STEERING**

Gear Type.....	Worm & Roller	Worm & Roller	Worm & Roller
Gear Oil.....	S.A.E. 90	S.A.E. 90	S.A.E. 90
King Pin Angle.....	5° 50'	5° 50'	5° 50'
Caster Angle.....	-1° ± ½°	-1° ± ½°	-1° ± ½°
Camber Angle.....	0° + ¾°	0° + ¾°	0° + ¾°
Toe-in.....	0 + 1/8" - 0	0 + 1/8" - 0	0 + 1/8" - 0
Tire Pressure			
Front & Rear.....	24 lb.	24 lb.	24 lb.

**DIMENSIONS**

Over-all length.....	213¾"	213¾"	213¾"
Max. Width.....	77⅞"	77⅞"	77⅞"
Wheelbase.....	122"	122"	122"

Weight—Consult the dealer who sold you the car, or the Motor Vehicle Commissioner in your state.

Model	Cavalier	Patrician	Packard
Chassis Symbols	2602	2606	2626

## ENGINE

Type.....	8 Cyl. "L" Head	8 Cyl. "L" Head	8 Cyl. "L" Head
Bore.....	3½"	3½"	3½"
Stroke.....	4¼"	4¼"	4¼"
A.M.A. Horsepower.....	39.2	39.2	39.2
Oil Capacity.....	7 qt.	7 qt.	7 qt.
Water Capacity.....	20 qt.	20 qt.	20 qt.
Heater Capacity.....	½ qt.	½ qt.	½ qt.
Thermostat Rating			
Standard.....	170°	170°	170°
Fuel Tank.....	20 gal.	20 gal.	20 gal.
Valve Clearance.....	Hydraulic	Hydraulic	Hydraulic

## COMPRESSION RATIO

Compression.....	8.0 to 1	8.0 to 1	8.0 to 1
------------------	----------	----------	----------

## BRAKE HORSEPOWER

Brake HP.....	180 @ 4000 RPM	180 @ 4000 RPM	180 @ 4000 RPM
---------------	----------------	----------------	----------------

## ELECTRICAL

Battery.....	17 Plate—100 hr.	17 Plate—120 hr.	17 Plate—120 hr.
Generator.....	45 Amp. Shunt	45 Amp. Shunt	45 Amp. Shunt
Regulator.....	Voltage & Current Control	Voltage & Current Control	Voltage & Current Control
Ign. Point Gap.....	0.016"	0.017"	0.017"
Spark Plugs.....	14 mm.	14 mm.	14 mm.
Spark Plug Gap.....	0.025"	0.025"	0.025"
Ignition Timing.....	6° bt/dc	6° bt/dc	6° bt/dc
Headlights.....	Sealed Beam	Sealed Beam	Sealed Beam

## TRANSMISSION

Type.....	Selective Silent Synchronized	Ultramatic Drive	Selective Silent Synchronized
Oil Capacity.....	2 pt.	12 qt.	2 pt.
Overdrive Capacity.....	1¼ pt.		1¼ pt.
Total Capacity.....	3¼ pt.		3¼ pt.

Model	Cavalier	Patrician	Packard
Chassis Symbols	2602	2606	2626

## CLUTCH

Type.....	Dry Disc 10½"		Dry Disc 10½"
Clutch Pedal Free Play.....	1¼" to 1½"		1¼" to 1½"

## REAR AXLE

Type.....	Hypoid	Hypoid	Hypoid
Oil Capacity.....	4¼ pt.	4¼ pt.	4¼ pt.
Ratio			
Standard.....	3.9 to 1		4.1 to 1
Overdrive.....	4.1 to 1		4.55 to 1
Ultramatic Drive.....	3.54 to 1	3.54 to 1	3.9 to 1

## SUSPENSION

Type.....	Independent Parallelogram	Independent Parallelogram	Independent Parallelogram
Springs			
Front.....	Coil	Coil	Coil
Rear.....	Leaf	Leaf	Leaf
Shock Absorbers			
Front & Rear.....	Direct Acting	Direct Acting	Direct Acting

## STEERING

Gear Type.....	Worm & Roller	Worm & Roller	Worm & Roller
Gear Oil.....	S.A.E. 90	S.A.E. 90	S.A.E. 90
King Pin Angle.....	5° 50'	5° 50'	5° 50'
Caster Angle.....	-1° ± ½°	-1° ± ½°	-1° ± ½°
Camber Angle.....	0° ± ¾°	0° ± ¾°	0° ± ¾°
Toe-in.....	0-¼"-0	0-¼"-0	0-¼"-0
Tire Pressure			
Front & Rear.....	24 lb.	24 lb.	26 lb.

## DIMENSIONS

Over-all length.....	218½"	218½"	240½"
Max. Width.....	77½"	77½"	77½"
Wheelbase.....	127"	127"	149"

Weight—Consult the dealer who sold you the car, or the Motor Vehicle Commissioner in your state.



Best for  
the finest

To give the "best" in service for the finest Packard ever built, every Packard Dealer's Service Department is staffed by Factory trained servicemen who are thoroughly familiar with every part of your car and who can best service it in the most efficient manner without lost time. There is a sincere desire of everyone in the Packard organization to be of service to you. This attitude exists with the Factory, Zone, Dealer, and the Dealers' Personnel.

The Packard Master Serviceman's emblem and certificate is awarded only to those selected Dealer Servicemen who have attended the Factory Schools and performed the actual mechanical work as prescribed by the Packard Service Department of the Factory.

These trained men are proud to have earned this award and are eager to serve your needs. When you visit your Packard Dealer and notice the emblem or certificate, you may have complete confidence that the service you receive will be the finest.



## Your Packard Deserves the Best Service Available



The Service Department at the Factory provides educational and training programs for the Dealer Servicemen, Service Managers, Parts Managers, and Partsmen to assure the Packard customer that the service he receives will always be the best.

At the Packard Dealership guesswork is never used to solve your wants or needs of the car, because skilled men and scientific diagnosis equipment is used to seek out and find your needs quickly.

Your Packard Dealer's Servicemen receive a constant flow of technical information from the Factory where the idea or method must be proven before being released. This data in the form of charts, manuals, books, bulletins, films, and records never ceases in the effort to provide the best for your car in the form of improvements whether they be mechanical or a better way to perform a service operation.

A few of these publications are illustrated on the following two pages:



## Manuals and Publications

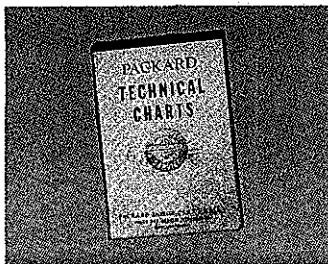

Technical charts are used in the presentation of training programs. In these charts, all major assemblies are graphically illustrated, providing a keener insight into the operation of your car.



The Packard Service Manual—a thorough manual complete in detail, giving all service operations in a step-by-step manner, assuring efficient service for Packard cars.

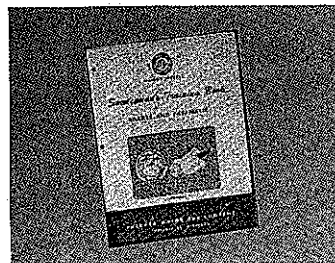

Serviceman's Training Books are constantly supplied through Training Programs to Dealer men to keep them abreast on car servicing, and many other varied subjects related to improving Packard service procedures.

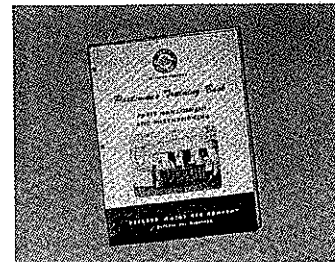

The Partsman's Training Book for Packard Dealers, Partsmen, and Parts Managers provides a greater understanding of owner parts requirements.

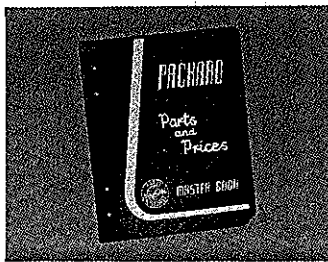

The Packard Parts Book is constantly maintained to assist Dealers in keeping Packard Parts available at all times.

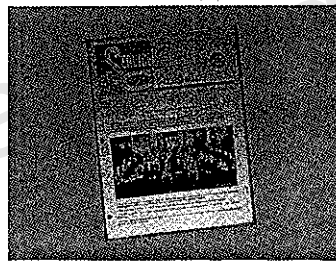

The Packard Service Counselor—a publication issued monthly to all Packard Dealers for the servicemen, acquainting them with the latest methods or changes in servicing your car.

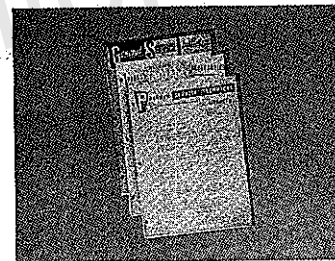

Service Bulletins immediately notify the Dealer of any product changes or servicing procedure. By this means, his service personnel are always informed.

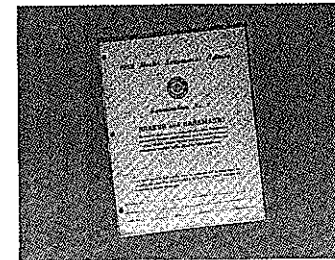

Written examinations covering all mechanical units of your car, such as Ultramatic Drive, front suspension, etc., are taken by all servicemen to determine whether or not they are eligible for a Serviceman's award emblem and certificate.

## Modern Tools and Equipment Used

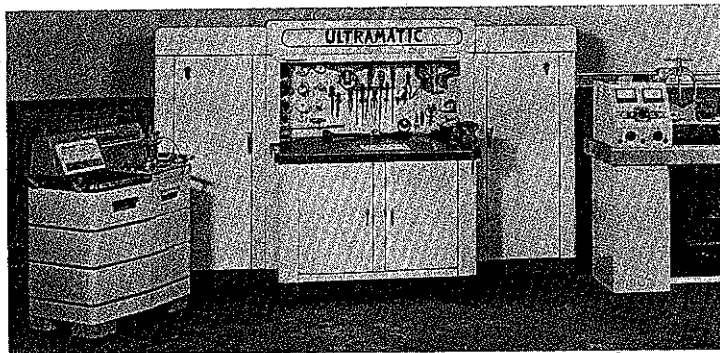

Your Packard Dealer carries Factory recommended tools and equipment that are specially designed to do the job better, faster, easier, and more economically. They are always of the highest quality and represent safe and effective means of making repairs without damage to the parts.

The Packard Dealer has a well equipped shop with diagnosis equipment to service the owner's car. This equipment quickly seeks out and finds the service needs for your car promptly without lost time and eliminating unnecessary repairs or adjustments.

Visit your Packard Dealer for normal periodic maintenance and adjustments. When you follow this counsel, you may feel confident your Packard car will operate with the utmost efficiency and provide many thousands of miles of carefree driving.

Packard Precision Parts are engineered and manufactured to rigid Factory production standards to provide safety and long life for the owner's car. These parts are precision made, always available, and nationally distributed. Packard Parts are so designed that the fit will always be perfect.

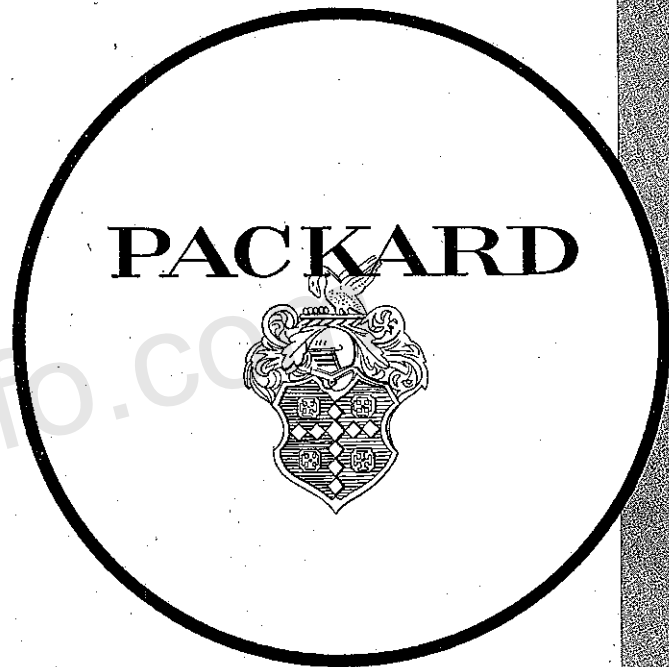

# ACCESSORIES

## LOOK TO PACKARD FOR THE FINEST IN ACCESSORIES

The accessories presented in this book have been carefully selected by Packard for you. They have been designed by Packard engineers and Packard and applied to your Packard by Packard, who created the compelling beauty of advanced contour.

Packard accessories not only improve your car, but at the same time will increase its value.

Engineered with the same regard for performance as the car itself, the accessories will make your car safer, more enjoyable, and more comfortable to drive.

So look through the pages that follow and select the Packard accessories that you need. Remember, they were created for you and are available only at your Packard Dealer. Packard for the accessories.

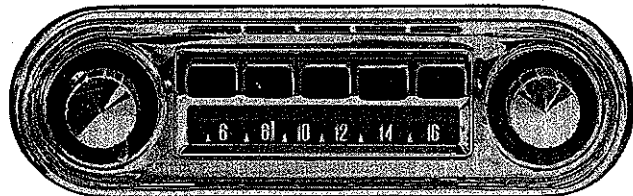
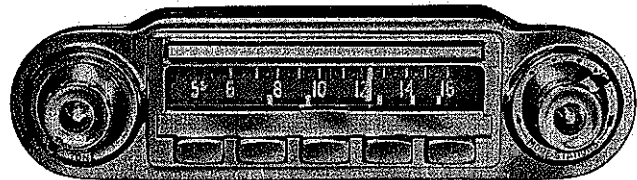

### THREE WAY TUNING RADIO

Wherever you drive there is no fumbling and hunting for the best on the air. And you have five pre-set push-button stations, and manual tuning everywhere.

### PUSH BUTTON RADIO

"Wherever you go, there's radio" and world's of motoring pleasure with this new seven tube Packard radio. The push buttons make five pre-selected stations instantly at your command, or you can manually select any station on the full-vision dial. You'll enjoy good quality and selectivity, even with long range reception.



### REAR SEAT SPEAKER

Because of its "floating" mounting, this large auxiliary speaker provides the ultimate in radio reception found only in the larger home radios. It operates independently of, or with, the front compartment speaker, giving you ultra-fine radio reception.

### ANTENNA

#### ELECTRIC

The Packard electric antenna moves up or down—to the desired height—at the touch of a push-pull control. Thus maximum quality radio reception is attained with effortless ease.

#### MANUAL

Engineered for the radio and your Packard, this gleaming stainless steel antenna extends to a length of 60-inches above the fender. Manually retracted with minimum effort.

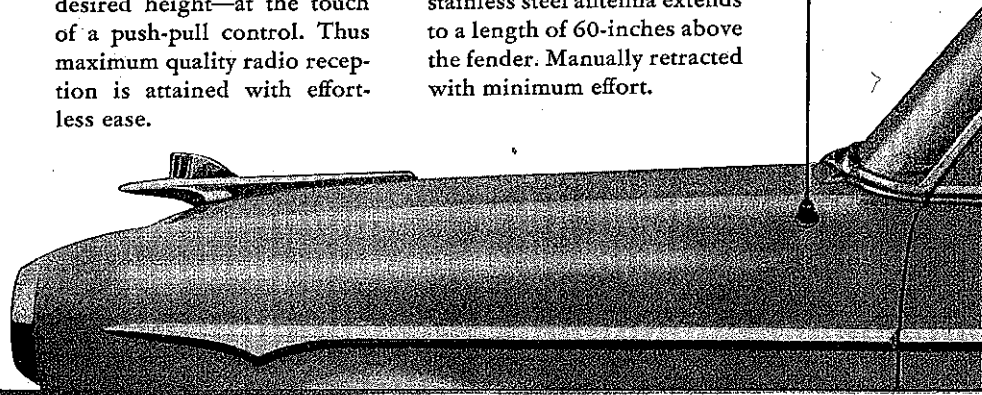

## HEATER AND DEFROSTER

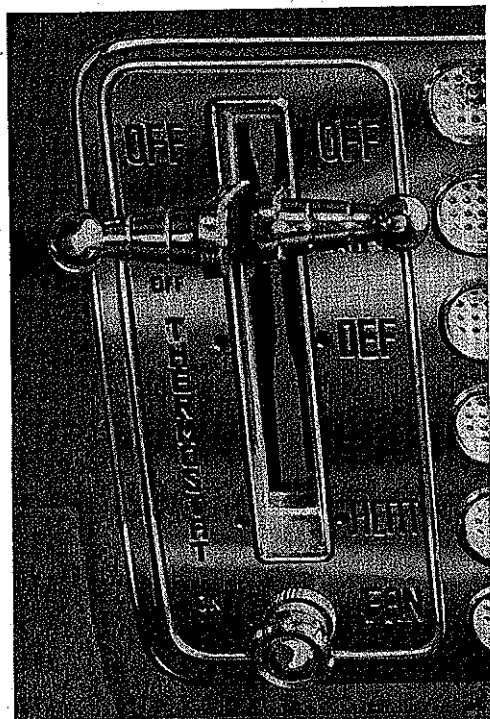

There's a world of comfort and safety built into the newly perfected Packard heating and ventilating system. Twin ducts provide heated fresh air as you need it, and the defroster vents across the entire windshield banish the dangers of steam, snow, and ice. With both air flow and temperature controlled from the instrument panel, you will enjoy fireside comfort—right in your Packard.

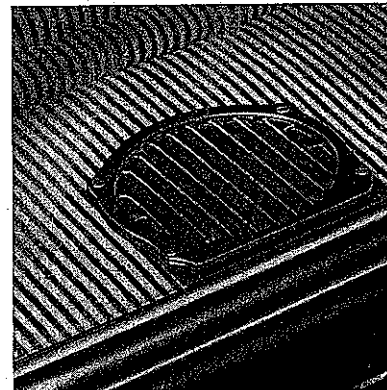
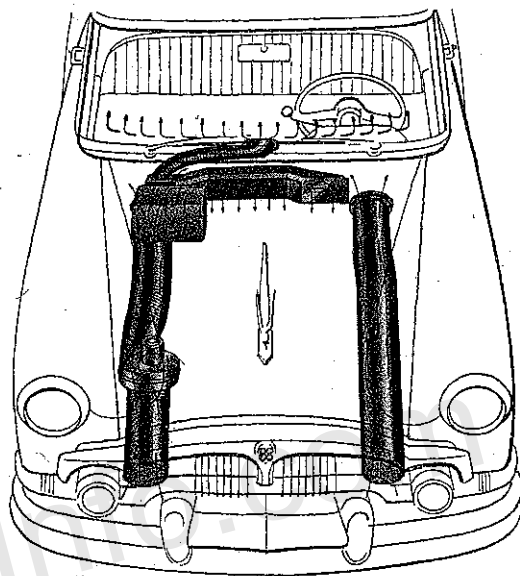

## REAR WINDOW DEFROSTER

This new Packard rear window defroster maintains a clear rear window for safe driving. Save yourself the annoyance of clearing fog, frost, and snow from the rear window. Synchronized with windshield defroster.

Special purpose lighting on your new Packard has been carefully planned for safety and convenience while driving at night.

The handsomely styled safety spotlight illustrated here is combined with a rear-view mirror and operated by a pistol grip from inside the car. Right and left hand models are available.

The powerful sealed beam of this spotlight will pick up nearby house numbers and street signs, or road signs up to a quarter of a mile distant.

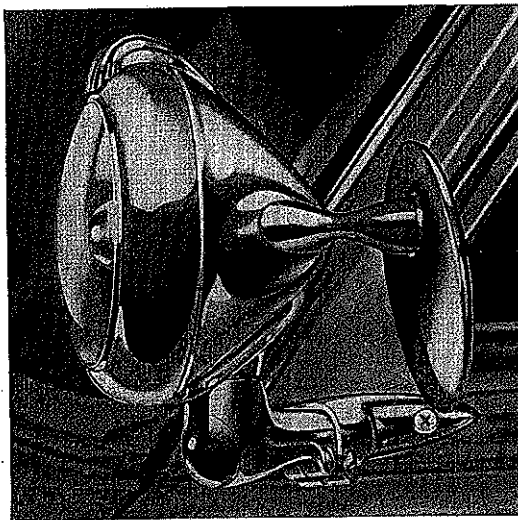

### **SPOTLIGHT**

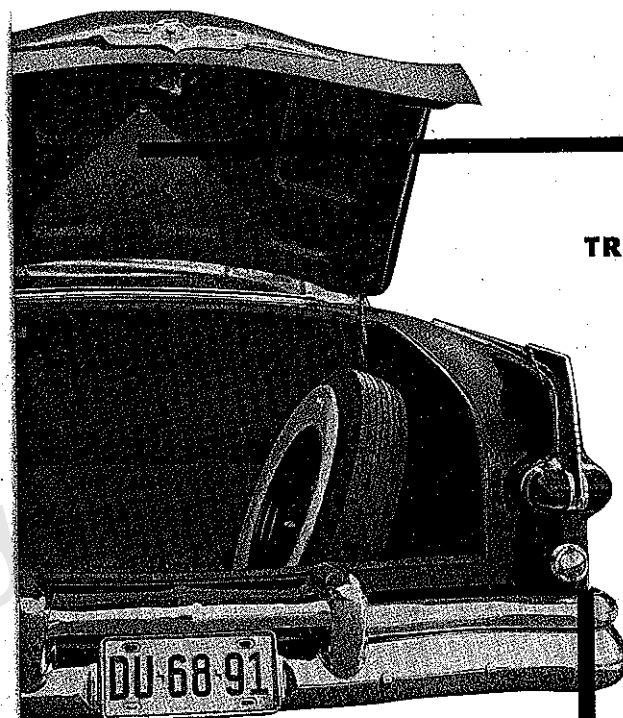

### **TRUNK LIGHT**

Just raise the rear deck lid and the whole luggage compartment is automatically flooded with light. The family motorist, business traveler, and sportsman will all appreciate the convenience of this trunk light.

### **BACK-UP LIGHTS**

You won't back into trouble with these Packard engineered back-up lights that operate automatically when you put the car into reverse, flooding the area behind you with bright, white light. Sold only in pairs.



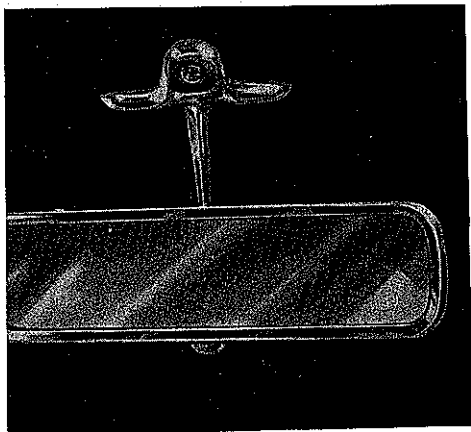

### TILT-TYPE MIRROR

A flip of the finger eliminates this reflection of bright lights in your rear view mirror when your Packard is equipped with this extra-wide glare-proof tilt-type mirror.

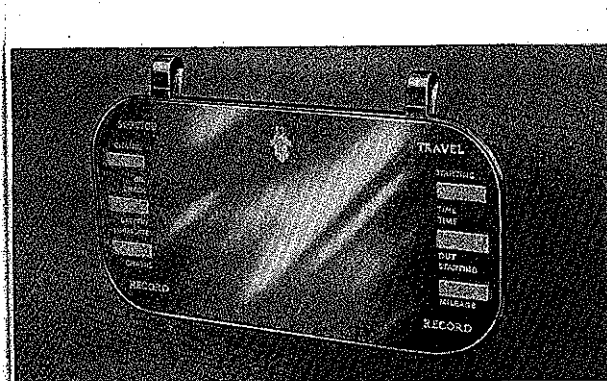

### VANITY MIRROR

You and milady will both enjoy the convenience of this vanity mirror that clips to the back of either inside sun visor. Frosted panels provide space to record service or trip information.

### BELT MOULDING TYPE MIRROR

Mounted on the mouldings at right and left of the car, these mirrors have a "built-in" appearance, and are easily adjusted to complete your view of traffic in the rear of your car.

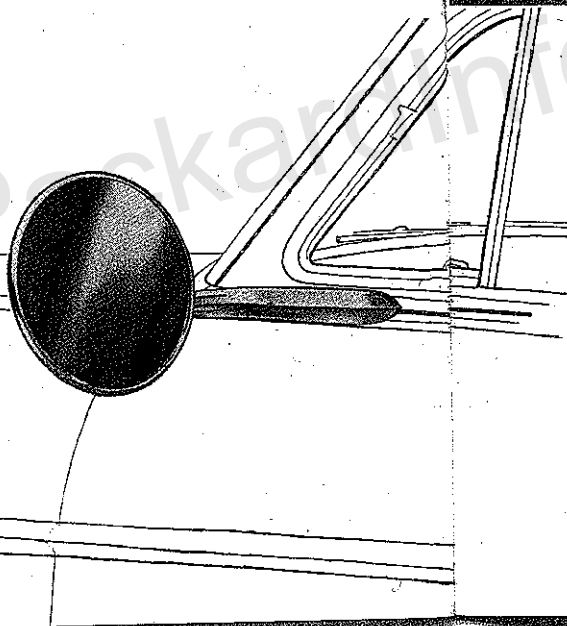

### CORMORANT ORNAM

Accent the clean cut styling of your Packard with the traditional Packard Cormorant hood ornament. Half a century the symbol of car ownership. This gr hood ornament is low in cost, rich in satisfaction.

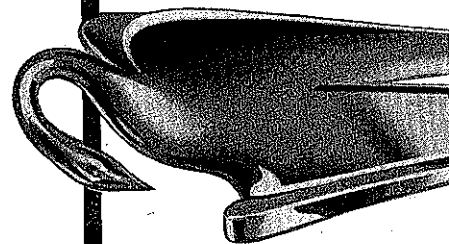

## REAR FENDER LOUVRES

Distinctively Packard in concept, these gleaming stainless steel louvres are inexpensive, easily mounted, and designed to enhance the appearance of your Packard.

## REAR FENDER TOP MOULDING

Tapered mouldings of gleaming chrome designed to fit on the top of the fenders blend perfectly into the ultra modern styling of your Packard.

## GASOLINE DOOR GUARD

Wheel trim rings of highly polished stainless steel add an extra look of luxury to your Packard. They are quickly and easily installed without special tools.

## WHEEL TRIM RINGS

Protect the fine finish of your new Packard during refueling with this smart chrome plated gasoline door guard. Adds a smart touch to your car.

## HAND SPOTLIGHT

This powerful 55,000 candle-power spotlight with a 12-foot cord which plugs into the cigar lighter, provides a versatile light for locating house numbers, street names, and road markers, indispensable to campers, tourists and vacationists.



## VENTSHADES

These highly polished stainless steel Ventshades permit windows to be left open for circulation of air during snowy or rainy weather, also reduce angle of sun entering car, adding to your driving comfort.

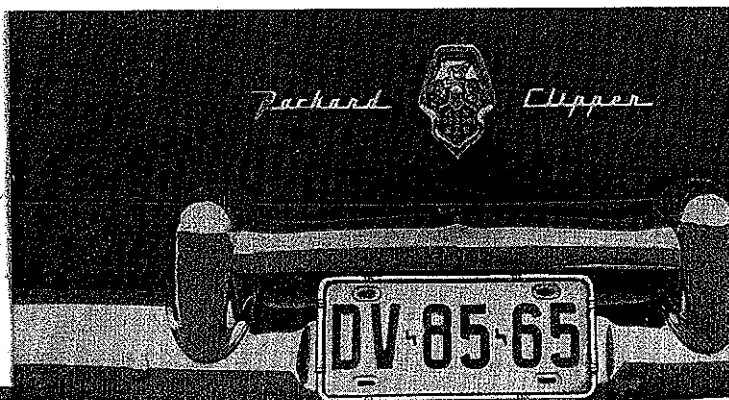

## LICENSE PLATE FRAMES

These bright chromium plated license plate frames improve the overall appearance of your car. Fully adjustable, they are easily attached to any size plate.

## EXHAUST PIPE TRIM

Built for Packard. Chrome Plated. Adds a touch of completeness to the car. Protect the rear bumper from the possibility of exhaust smudge by deflecting gases downward to the road.

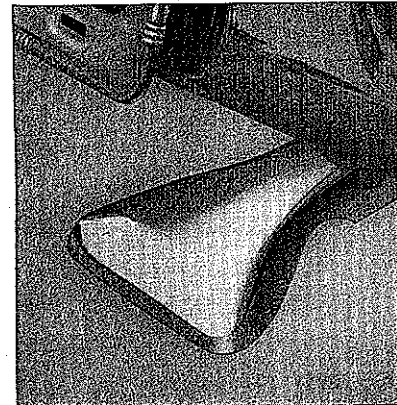

## SEAT COVERS

Preserve and protect the fine upholstery in your Packard with Seat Covers expressly tailored for Packard alone. Matched in beauty and utility, these customized Seat Covers add a note of distinction to the elegant Packard interiors. Added freedom of movement, summertime coolness and year-around driving comfort are yours when your Packard is equipped with Packard Seat Covers.

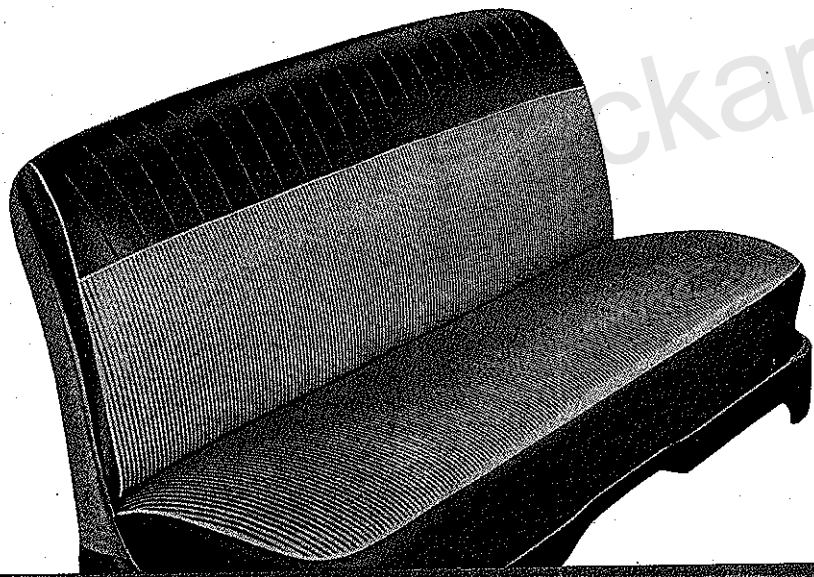

## FABRICS

**SARAN PLASTIC** The smooth, colorful, durable Saran Seat Covers offer the maximum in protection and comfort. Tailored to harmonize with Packard's rich interiors in smart Buckingham stripes with harmonizing Bolta-Quilt pleated bolsters. Easily cleaned by a whisk of a damp cloth. Saran Seat Covers offer so much for so little investment.

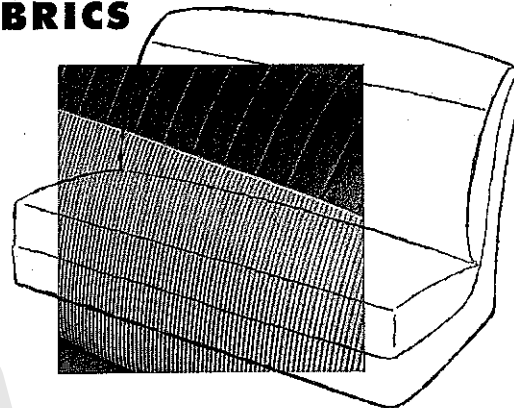

**NYLON** Beautiful nylon prints custom tailored in maroon, blue, and green patterns are trimmed in solid colors. Patterns are designed to minimize the appearance of soil and stay fresh longer. Water repellent, fade resistant and long wearing. Easily removed for laundering.

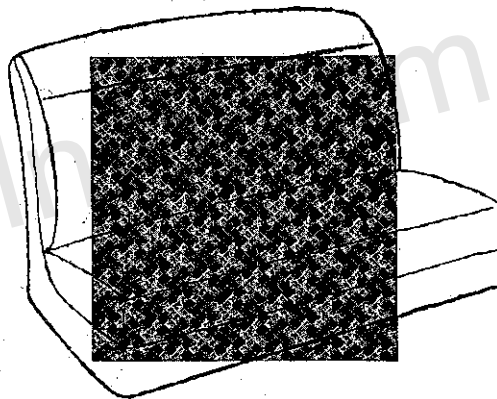

**SAN-TEX** Bold, colorful plaid patterns trimmed in durable rayon in maroon, green or blue characterize these San-Tex woven fiber seat covers. The lacquered surface is smooth to the touch . . . cool in summer, comfortable in winter. Moderately priced. Perfectly tailored and easy to clean.

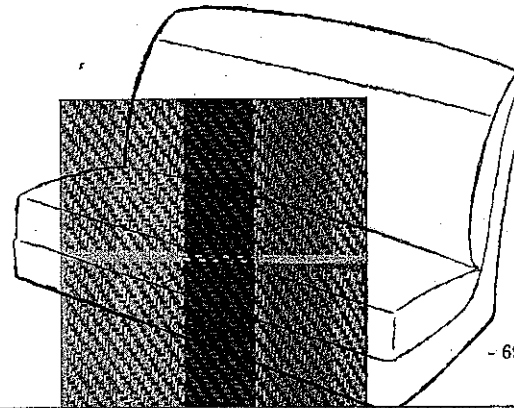

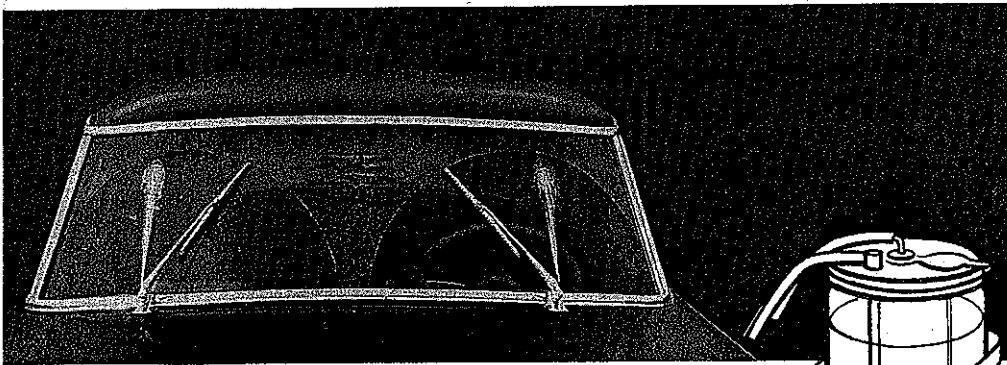

### WINDSHIELD WASHER

Banish the hazards of a dirty windshield or flying mud with this quick action windshield washer that assures clear vision under all driving conditions. Liquid is sprayed on the windshield at the touch of a button; your windshield wiper blades do the cleaning. Quickly installed, the assembly includes reservoir, pump, hose, control and jets. Have the satisfaction of knowing, under normal conditions, you will have perfect visibility anytime—anywhere!

### OUTSIDE VISOR

Styled to be part of today's modern Packard, this handsome outside visor eliminates sun and sky glare, keeps car cooler, reduces eye strain and driving fatigue. Extra protection against windshield icing in winter. Painted to match the car and trimmed with stainless steel.

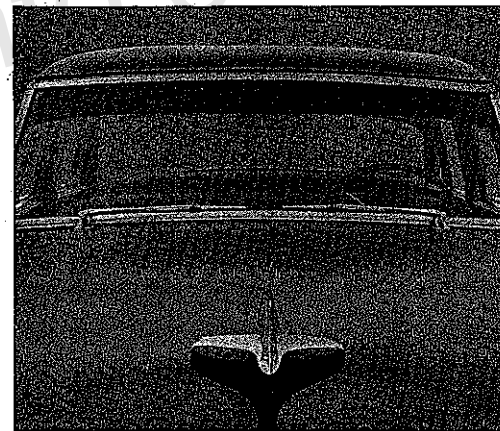
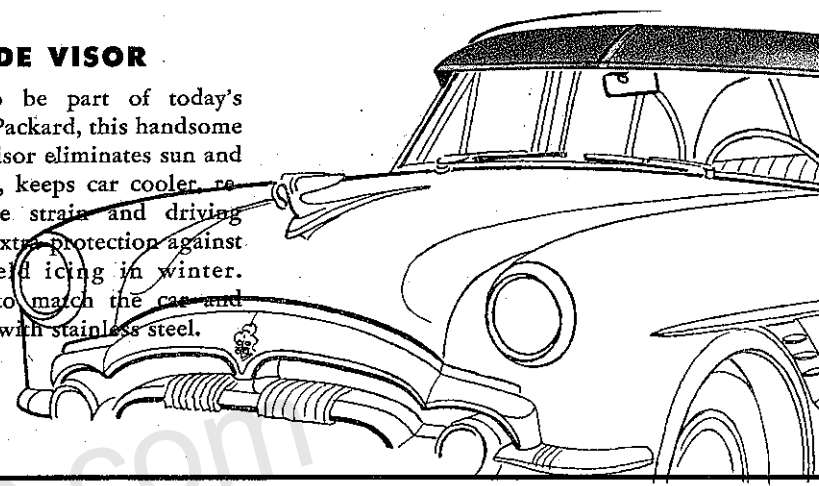

### WINDSHIELD LIGHT FILT

This non-glare plastic light filter offers dependable protection against sun glare without reducing the area of vision. Tinted in eye soothing green if fits snugly on the inside of the windshield.



### **GASOLINE FILTER**

Experienced motorists know that the gasoline filter is the ounce of prevention that is worth a pound of cure! Installed just ahead of the carburetor it filters out dirt, gummy foreign matter and water, providing permanent protection for the Packard engine.



### **OIL FILTER**

Enjoy the economy of more miles between oil changes with this efficient oil filter that removes dirt, sludge, and abrasive particles from the oil in your Packard engine. Experienced lubrication men know that clean oil is the best oil for your engine.

### **FLOOR WEAR PAD**

Protect the permanent floor coverings of both front and rear compartments with these deep ribbed extra-heavy floor mats. Made of high quality rubber in maroon, green, gray, and black, they are very durable and easily removable for cleaning.

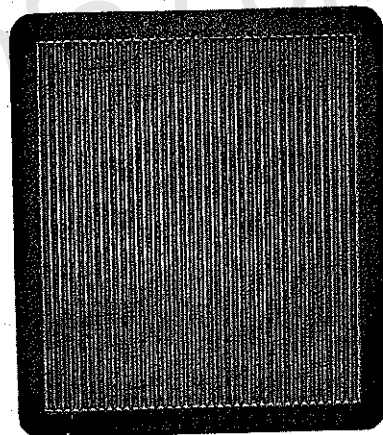

### **ACCELERATOR WEAR PAD**

Eliminate the possibility of wear with this ribbed non-slip accelerator pad. Also, it may be installed over a spot that is already worn. Does not interfere with pedal operation. Comfortable. Easily installed.

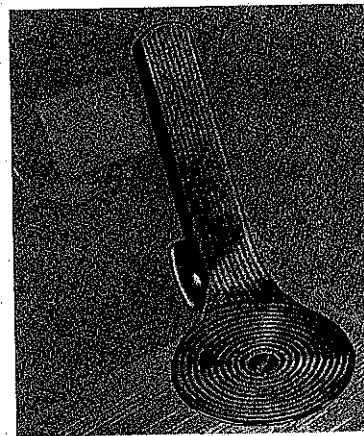

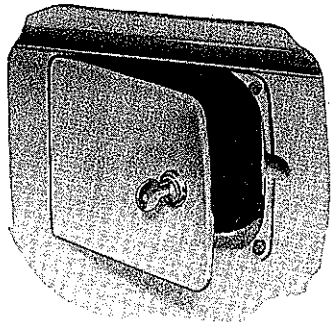

### **GASOLINE DOOR LOCK**

Protect the fuel supply in your Packard against theft or tampering with this effective gasoline door lock. Key cannot be removed unless cap is locked.

### **COAT HOOK**

Arrive at your destination with that fresh well-pressed look by making good use of these convenient coat hooks that are easily installed on either side of the car.

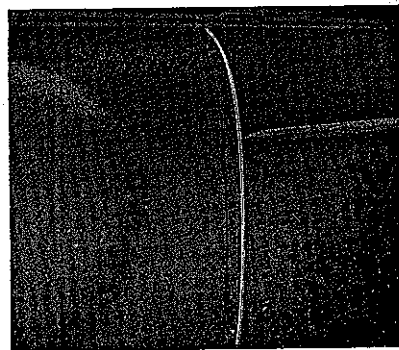
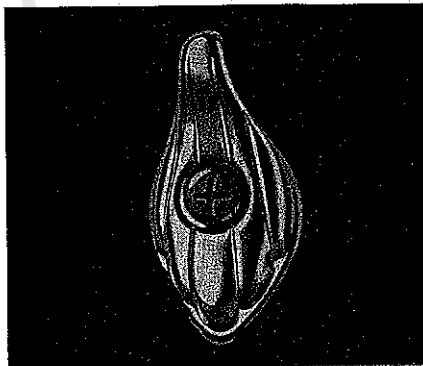

### **DOOR GUARDS**

Protective door guards are smart and practical. The narrow stainless steel beading snaps over the rear edge of front doors and prevents chipping, denting, scratching and rusting.

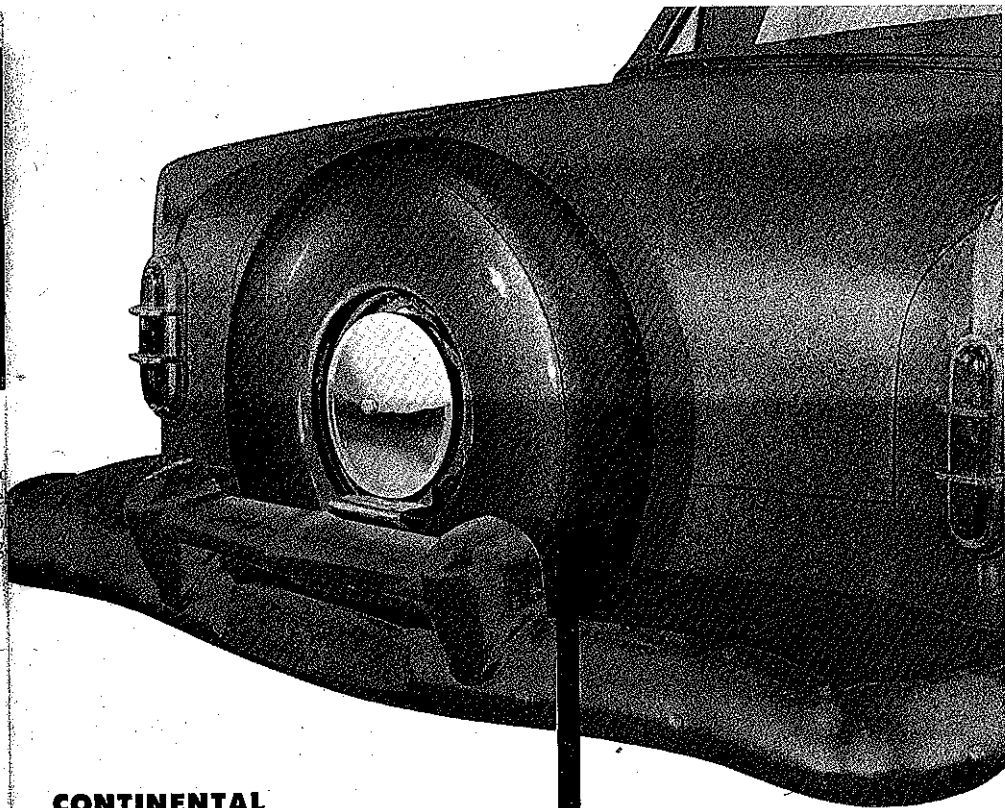

### **CONTINENTAL REAR TIRE CARRIER**

The continental rear tire carrier is designed for the Packard Mayfair, Convertible, Clipper, and Clipper Deluxe owner who desires to give his car the continental flair.

## CAR CARE

**LUSTUR-SEAL**—Packard has excellent reasons for recommending Lustur-Seal as a scientific method of cleaning, restoring and protecting the finish of your car. Applied when the car is new, it will retain the original luster of the flawless Packard finish by sealing it against sun, salt-air, chemicals, dust, grime and road film. Once applied, the Lustur-Seal beauty will last indefinitely, if cared for periodically with Lustur-Seal Haze Cream.



**SEALZIT**—Little leaks that may appear around the windshield or rear window are easily and permanently sealed with Sealzit.



### PACKARD WHITE SIDE WALL TIRE CLEANER

Retain the distinctive beauty of white side wall tires by removing all dirt and scuff marks with this effective cream paste soap.

**BODY CLEANER AND POLISH**—Easily applied, cleans and polishes in one operation.

**FABRIC CLEANER**—Safely and quickly removes spots, smudges and stains from upholstery.

**CHROME CLEANER**—Restore original brilliance and gleam to all bright metal parts.

**RUST PREVENTATIVE**—A special chemical prevents the formation of rust and scale in the radiator.

**TAR REMOVER**—harmless quick acting solvent that softens and dissolves tar, asphalt and road oil.



### CHROME PROTECTOR

A clear protector. Helps retain the original brilliance and gleam to all chromium and bright metal parts.

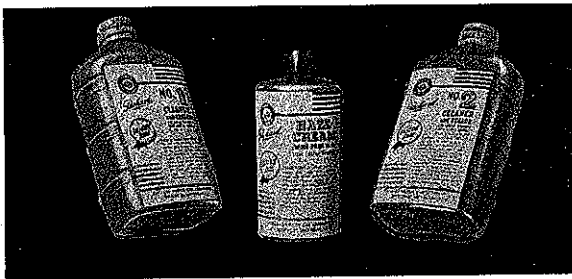

**WINDSHIELD WASHER SOLVENT**—To get the best results with your windshield washer add this windshield washer solvent to the water. Cleans effectively and prevents freezing.

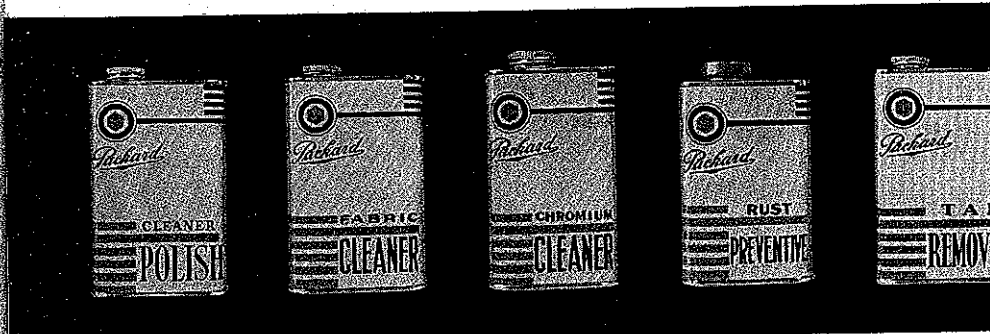



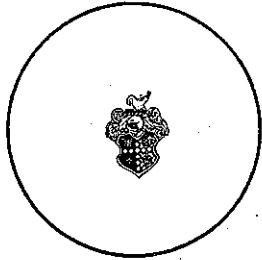

PACKARD MOTOR CAR COMPANY  
Detroit 32, Michigan

NOTES

PackardInfo.com